

# Krefeld-Lehmheide, Kölner Str. 186

Erstellt am  
2021-07-03

---

Standort  
Kölner Straße 186  
47805 Krefeld



## ▼ 2. Untergeschoss

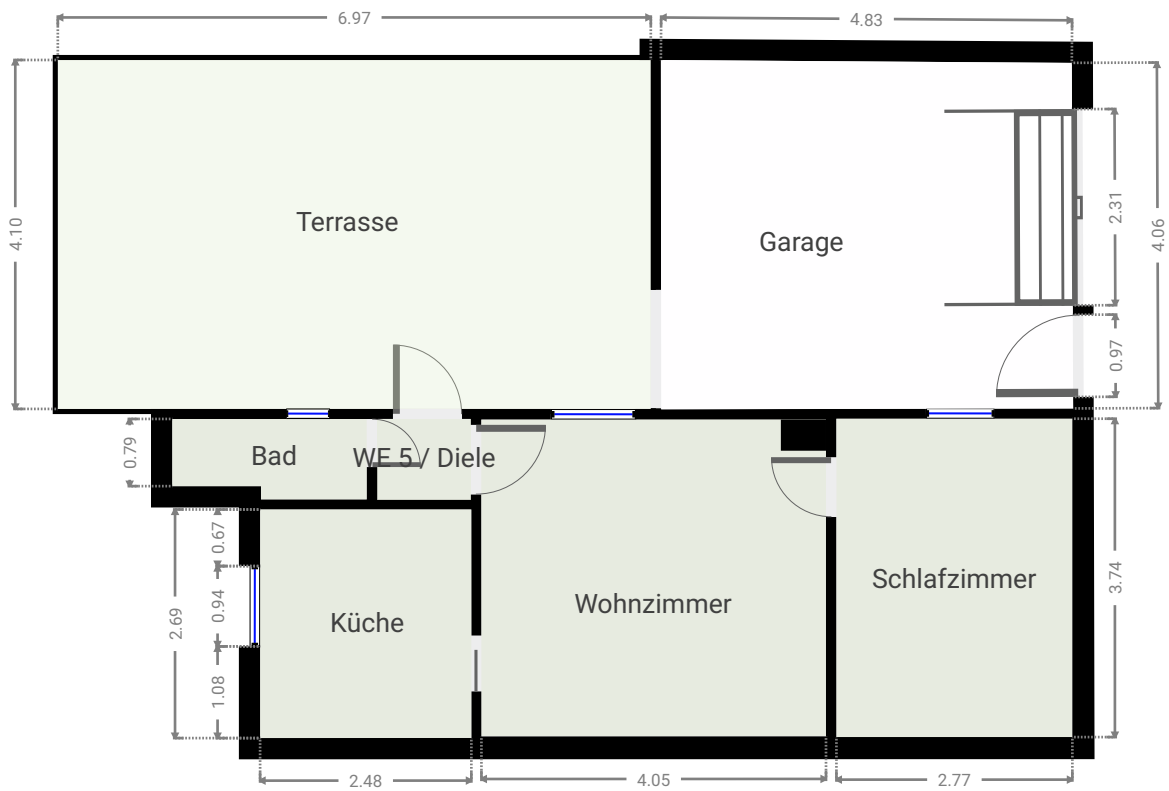

▼ **Wohnzimmer**  
2. Untergeschoss

BREITE: 4.05 m • LÄNGE: 3.72 m • DECKENHÖHE: 2.20 m  
BEREICH: 15.09 m<sup>2</sup> • UMFANG: 15.55 m

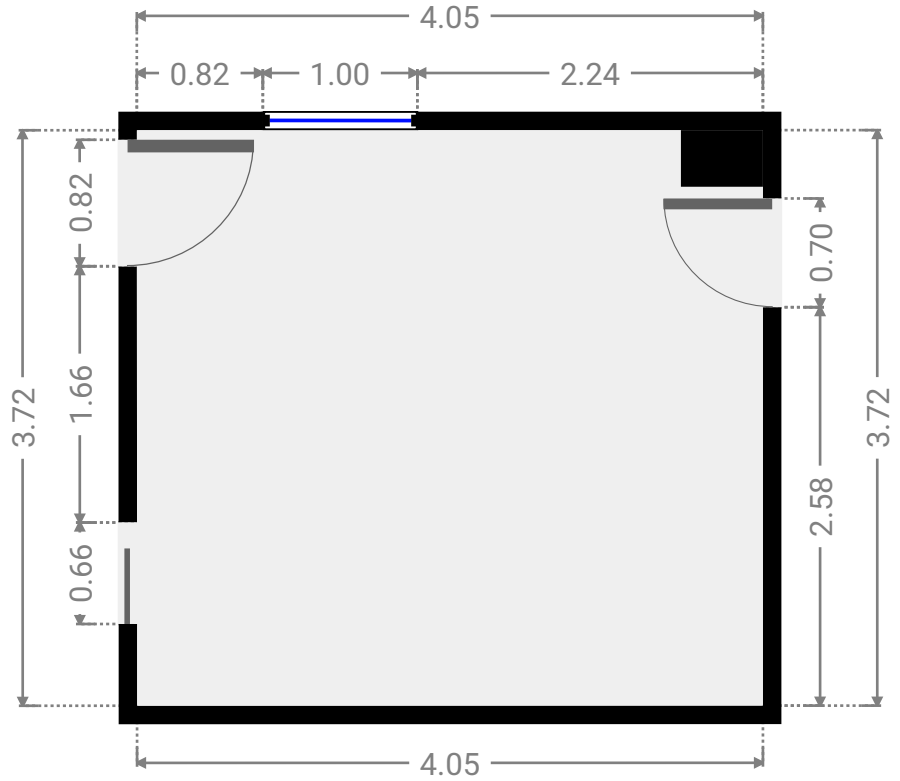
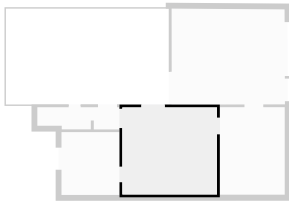

▼ **Schlafzimmer**  
2. Untergeschoss

BREITE: 2.77 m • LÄNGE: 3.74 m • DECKENHÖHE: 2.20 m  
BEREICH: 10.38 m<sup>2</sup> • UMFANG: 13.03 m

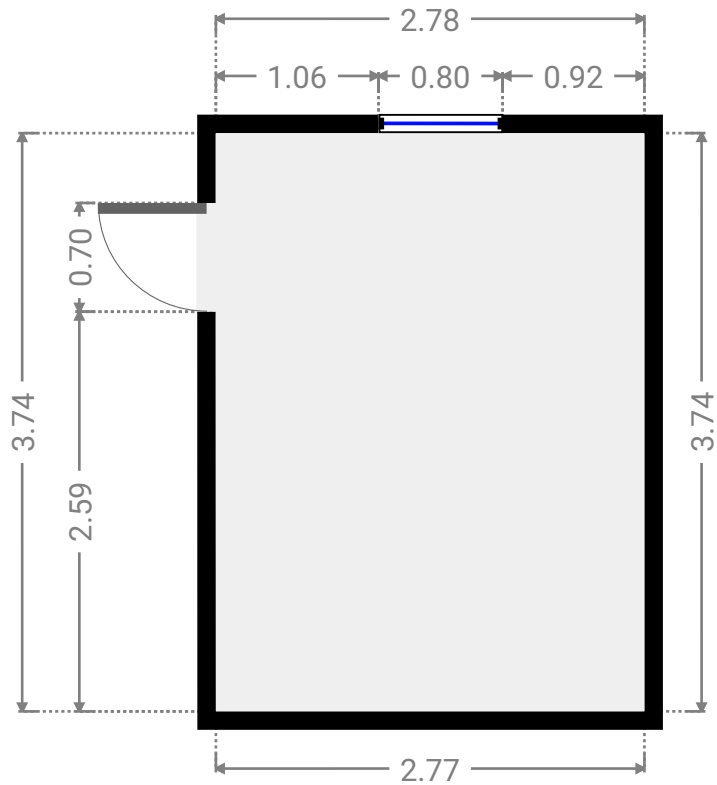
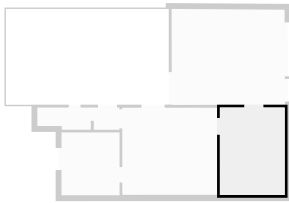

▼ **Küche**  
2. Untergeschoss

BREITE: 2.48 m • LÄNGE: 2.69 m • DECKENHÖHE: 2.20 m  
BEREICH: 6.67 m<sup>2</sup> • UMFANG: 10.34 m

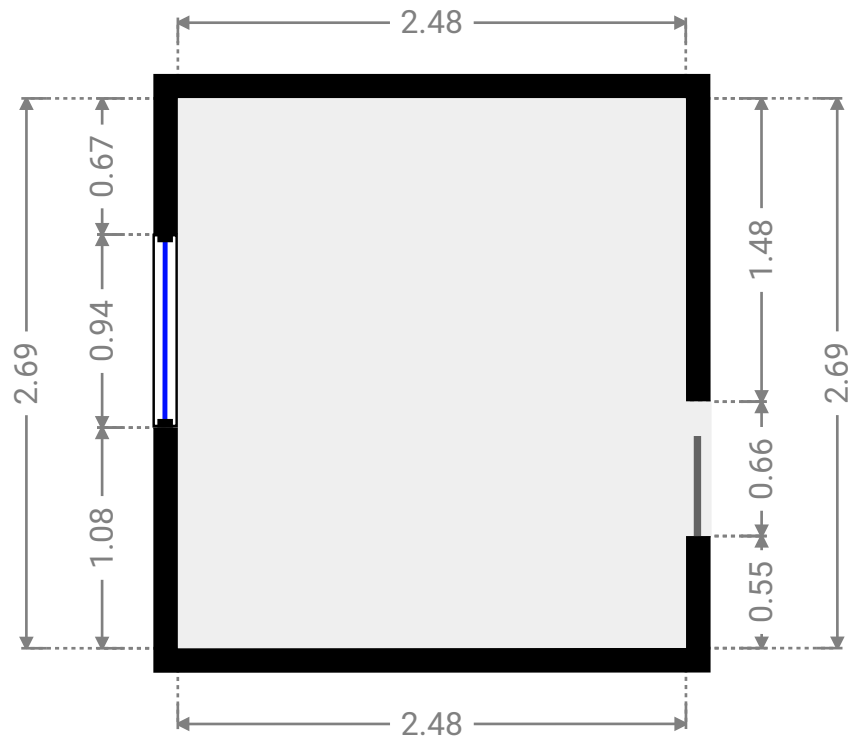
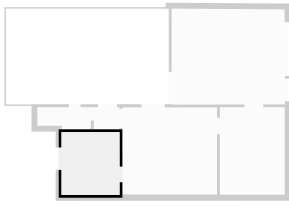

▼ **WE 5 / Diele**  
2. Untergeschoss

BREITE: 1.09 m • LÄNGE: 0.95 m • DECKENHÖHE: 2.20 m  
BEREICH: 1.04 m<sup>2</sup> • UMFANG: 4.08 m

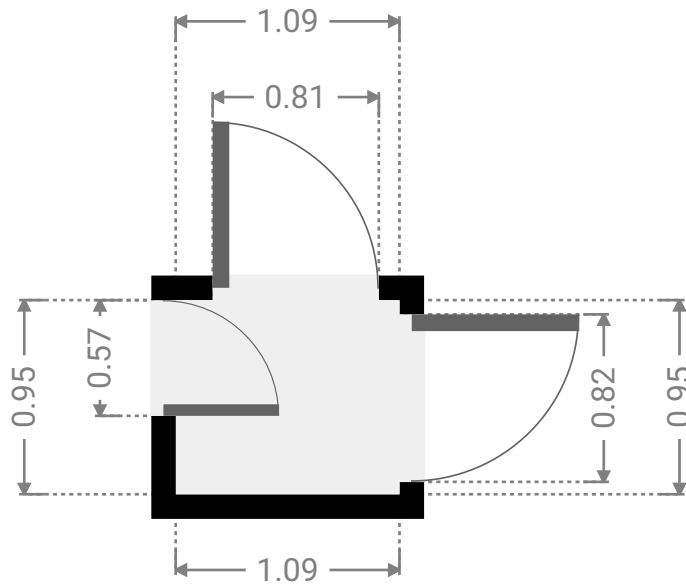
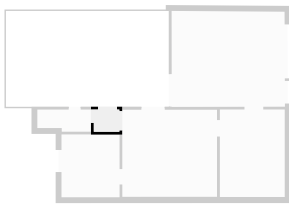

▼ **Bad**  
2. Untergeschoss

BREITE: 2.29 m • LÄNGE: 0.95 m • DECKENHÖHE: 2.20 m  
BEREICH: 2.00 m<sup>2</sup> • UMFANG: 6.46 m

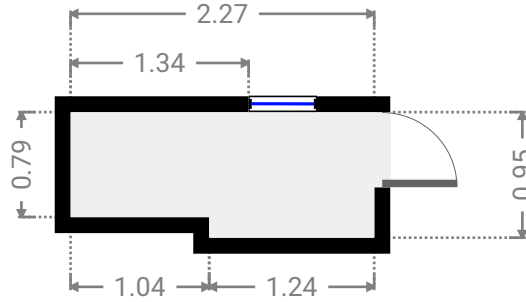
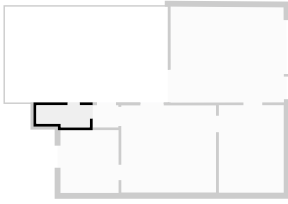

▼ **Garage**  
2. Untergeschoss

BREITE: 4.84 m • LÄNGE: 4.11 m • DECKENHÖHE: 3.06 m  
BEREICH: 19.75 m<sup>2</sup> • UMFANG: 17.84 m

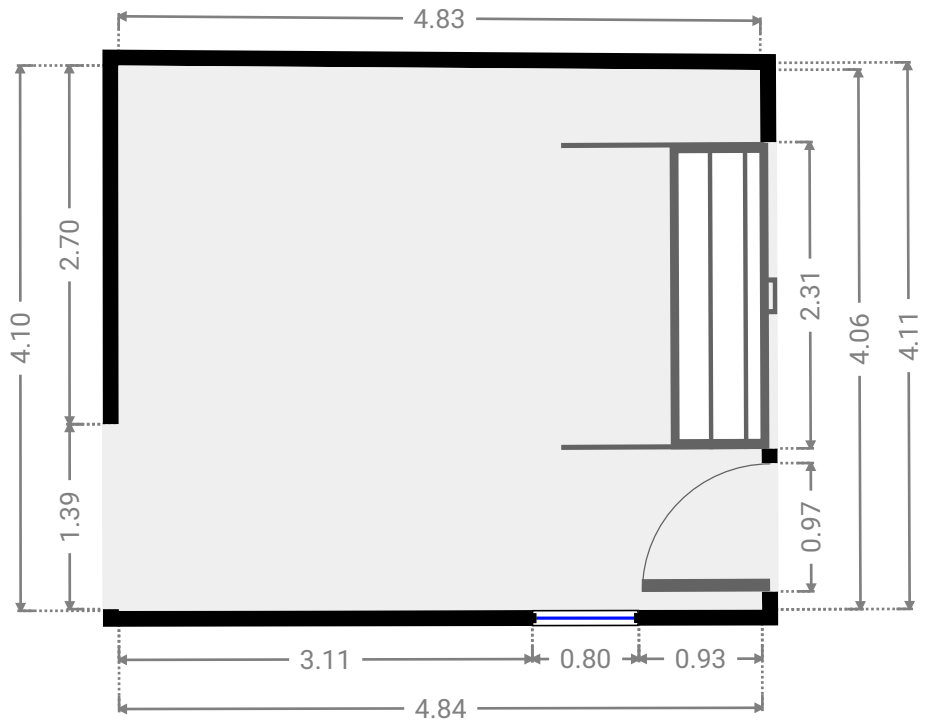
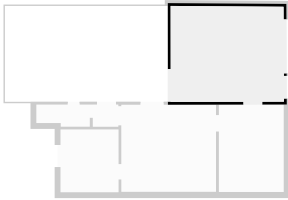

▼ **Terrasse**  
2. Untergeschoss

BREITE: 6.97 m • LÄNGE: 4.10 m • DECKENHÖHE: 2.20 m  
BEREICH: 28.59 m<sup>2</sup> • UMFANG: 22.14 m

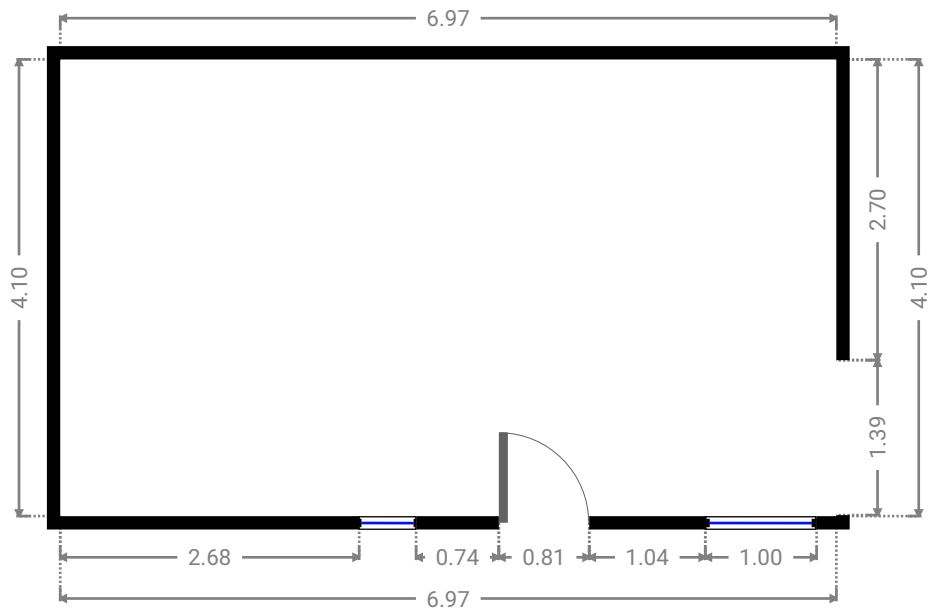
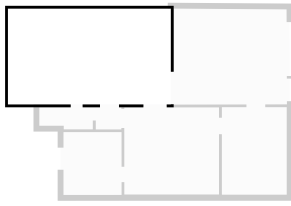

# ▼ Kellergeschoss

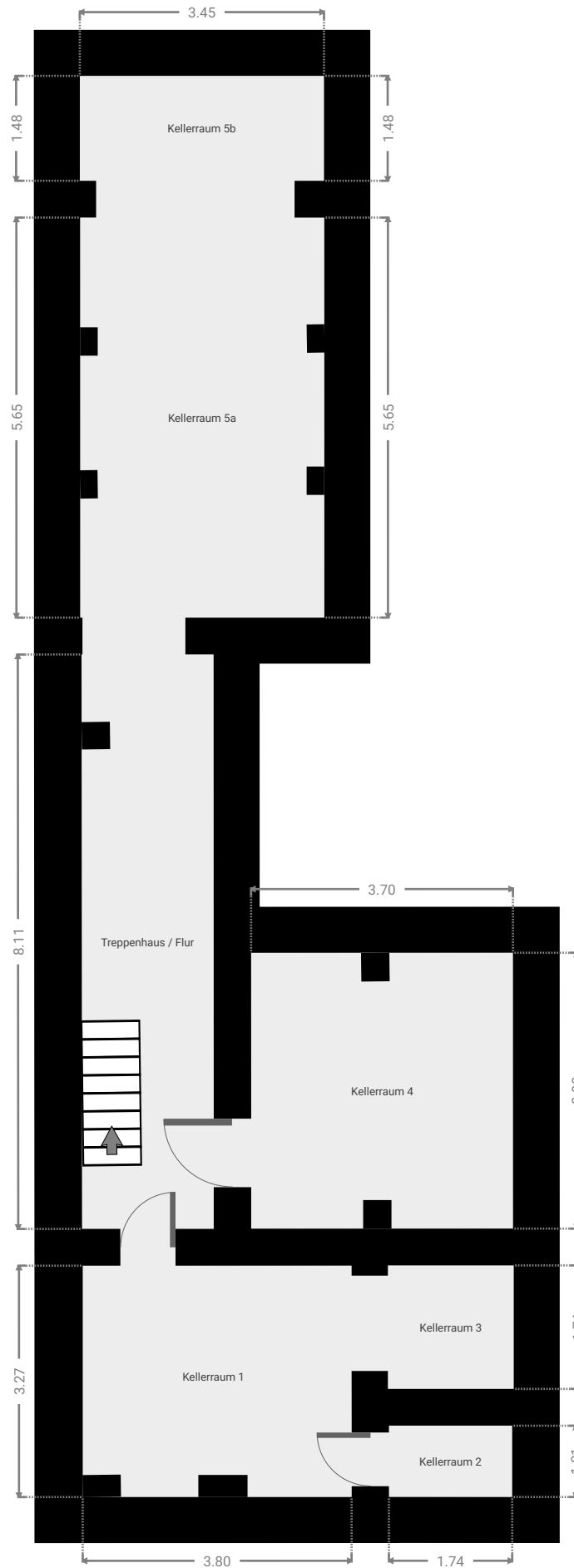



▼ **Treppenhaus / Flur**  
Kellergeschoss

BREITE: 1.87 m • LÄNGE: 8.11 m • DECKENHÖHE: 3.10 m  
BEREICH: 15.12 m<sup>2</sup> • UMFANG: 19.95 m

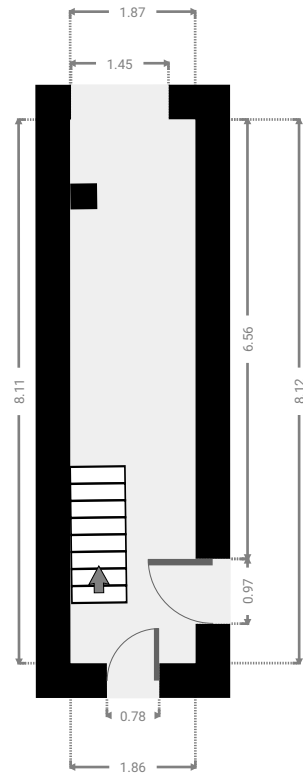

▼ **Kellerraum 5a**  
Kellergeschoss

BREITE: 3.45 m • LÄNGE: 5.65 m  
BEREICH: 19.49 m<sup>2</sup> • UMFANG: 18.20 m

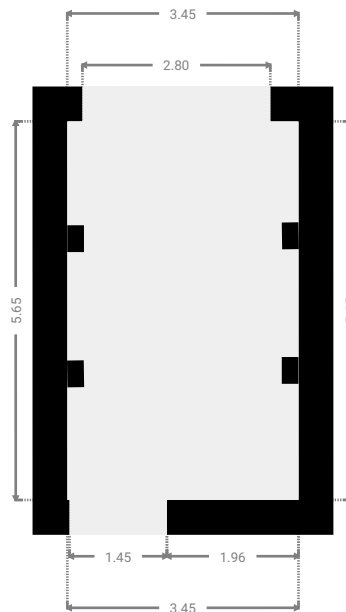

▼ **Kellerraum 5b**  
Kellergeschoss

BREITE: 3.45 m • LÄNGE: 1.48 m  
BEREICH: 5.11 m<sup>2</sup> • UMFANG: 9.86 m

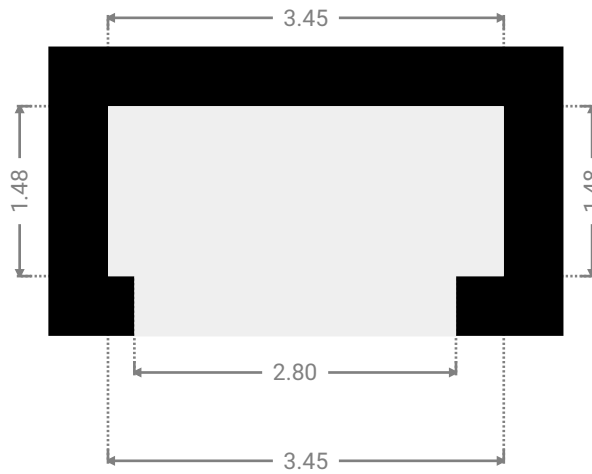

▼ **Kellerraum 4**  
Kellergeschoss

BREITE: 3.70 m • LÄNGE: 3.90 m • DECKENHÖHE: 2.90 m  
BEREICH: 14.42 m<sup>2</sup> • UMFANG: 15.19 m

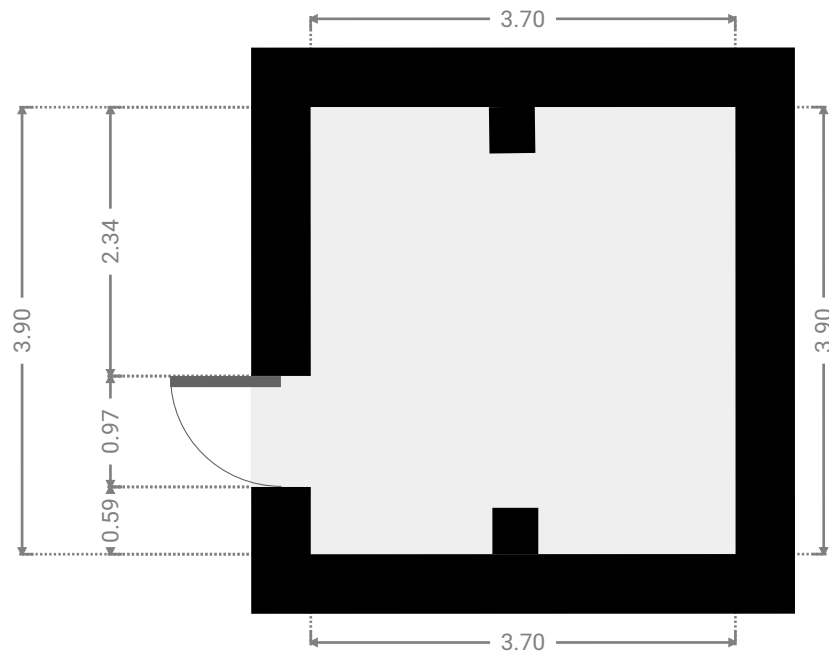

▼ **Kellerraum 1**  
Kellergeschoss

BREITE: 3.80 m • LÄNGE: 3.27 m  
BEREICH: 12.42 m<sup>2</sup> • UMFANG: 14.13 m

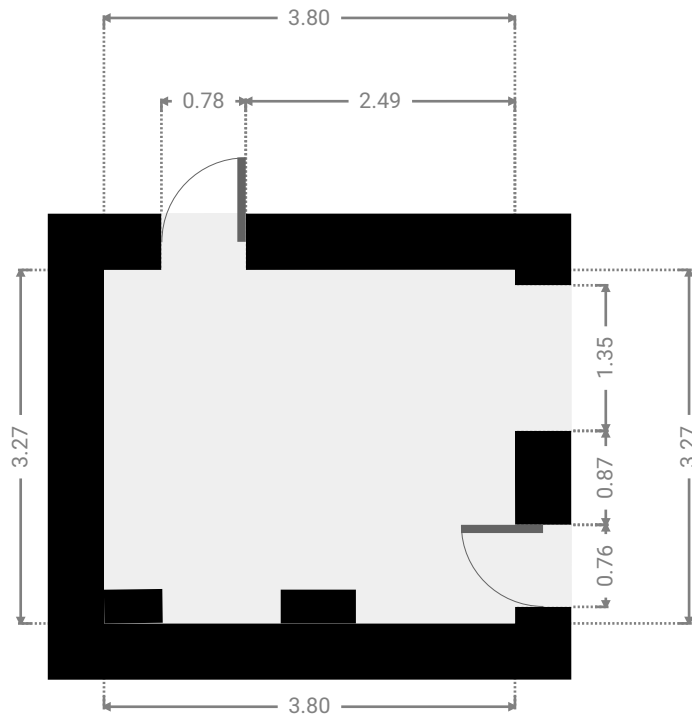

▼ **Kellerraum 3**  
Kellergeschoss

BREITE: 1.78 m • LÄNGE: 1.74 m  
BEREICH: 3.10 m<sup>2</sup> • UMFANG: 7.04 m

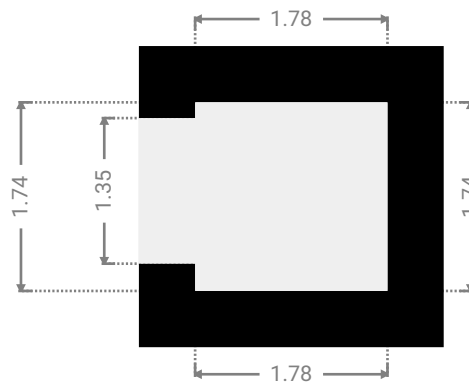

▼ **Kellerraum 2**  
Kellergeschoss

BREITE: 1.74 m • LÄNGE: 1.01 m  
BEREICH: 1.75 m<sup>2</sup> • UMFANG: 5.50 m

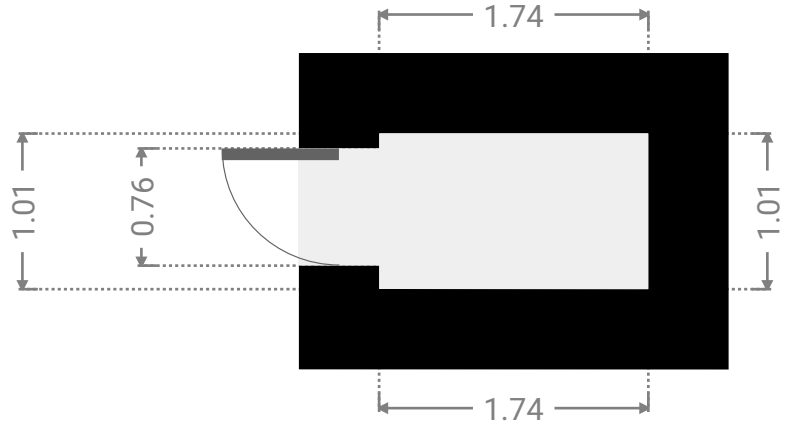

▼ Erdgeschoss

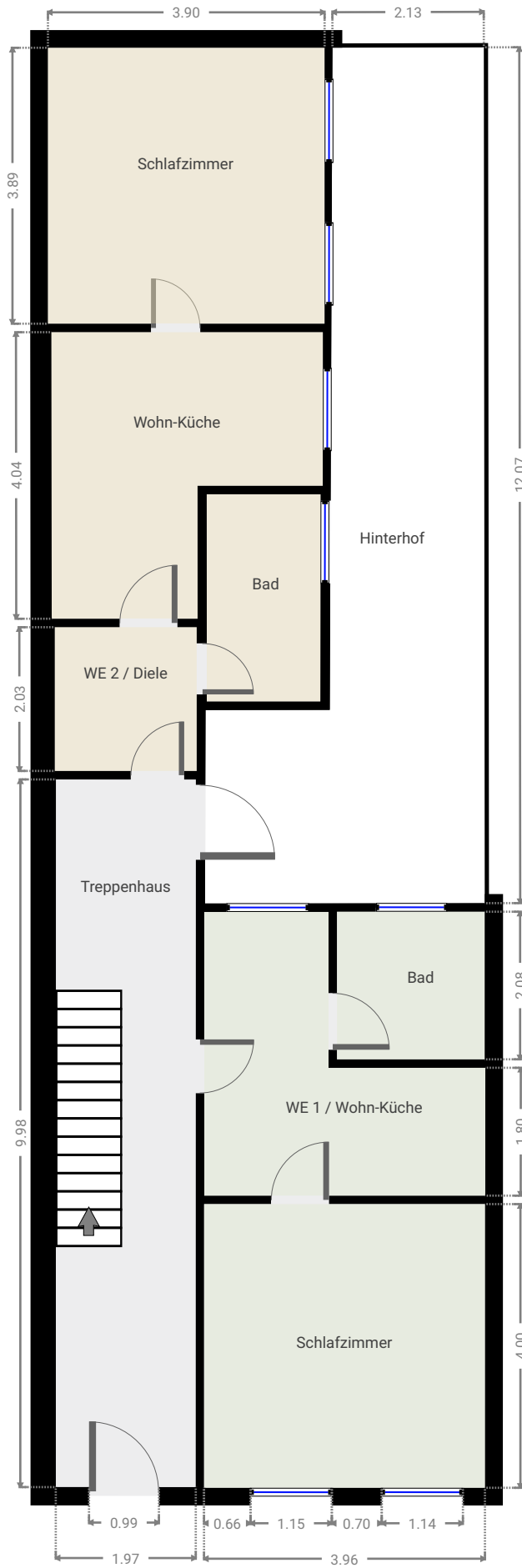

▼ **Treppenhaus**  
Erdgeschoss

BREITE: 1.97 m • LÄNGE: 9.98 m • DECKENHÖHE: 3.72 m  
BEREICH: 19.70 m<sup>2</sup> • UMFANG: 23.90 m

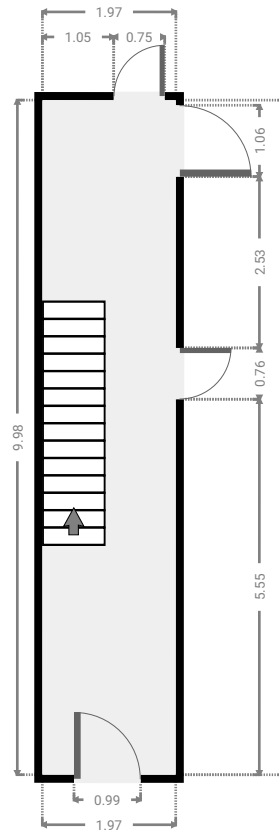
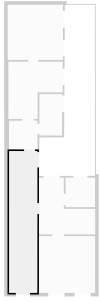

▼ **Schlafzimmer**  
Erdgeschoss

BREITE: 3.96 m • LÄNGE: 4.00 m • DECKENHÖHE: 3.72 m  
BEREICH: 15.84 m<sup>2</sup> • UMFANG: 15.92 m

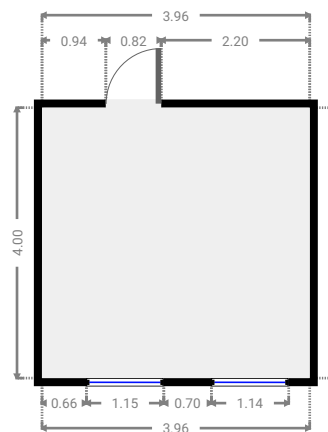
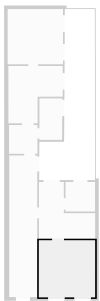

▼ **WE 1 / Wohn-Küche**  
Erdgeschoss

BREITE: 3.96 m • LÄNGE: 4.00 m • DECKENHÖHE: 3.72 m  
BEREICH: 10.99 m<sup>2</sup> • UMFANG: 15.92 m

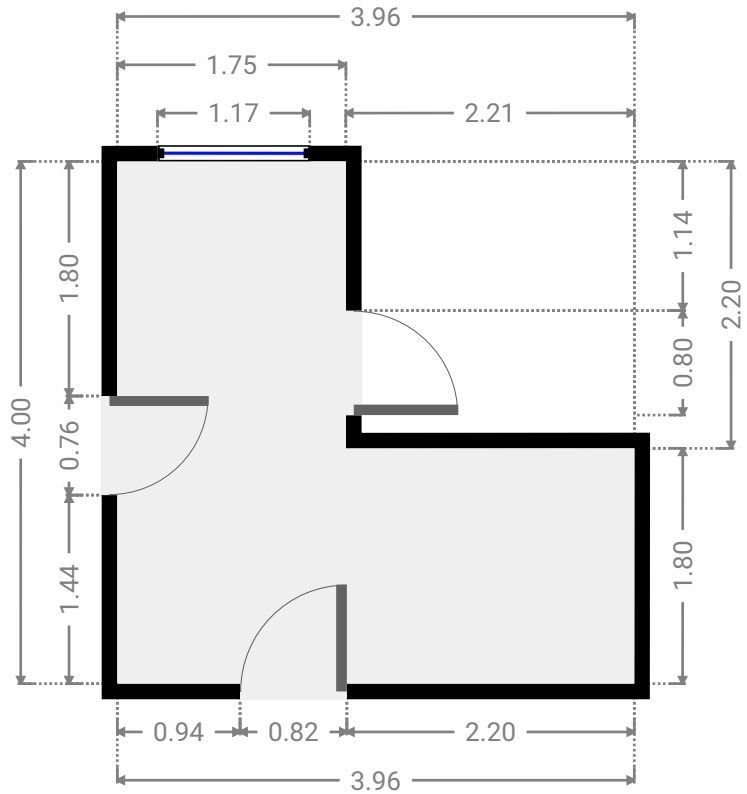
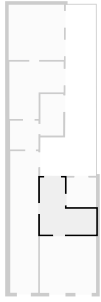

▼ **Bad**  
Erdgeschoss

BREITE: 2.08 m • LÄNGE: 2.08 m • DECKENHÖHE: 3.72 m  
BEREICH: 4.33 m<sup>2</sup> • UMFANG: 8.32 m

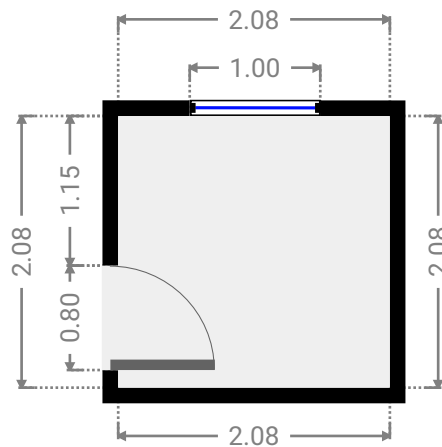
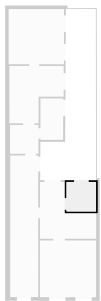

▼ **WE 2 / Diele**  
Erdgeschoss

BREITE: 2.00 m • LÄNGE: 2.03 m • DECKENHÖHE: 3.72 m  
BEREICH: 4.05 m<sup>2</sup> • UMFANG: 8.05 m

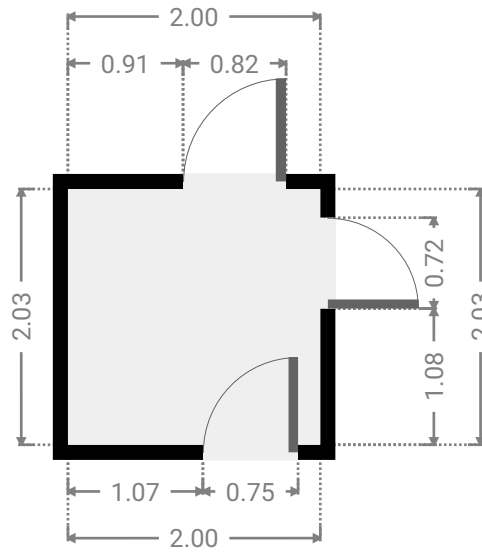
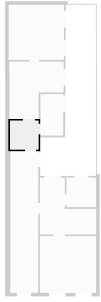

▼ **Wohn-Küche**  
Erdgeschoss

BREITE: 3.83 m • LÄNGE: 4.04 m • DECKENHÖHE: 3.72 m  
BEREICH: 12.14 m<sup>2</sup> • UMFANG: 15.73 m

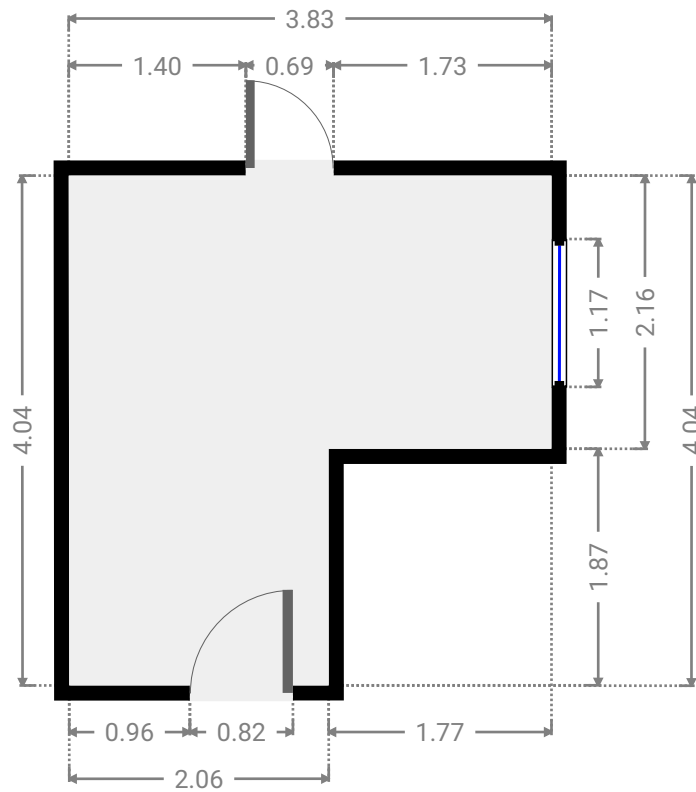
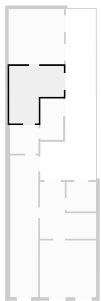

▼ **Schlafzimmer**  
Erdgeschoss

BREITE: 3.90 m • LÄNGE: 3.89 m • DECKENHÖHE: 3.72 m  
BEREICH: 15.17 m<sup>2</sup> • UMFANG: 15.58 m

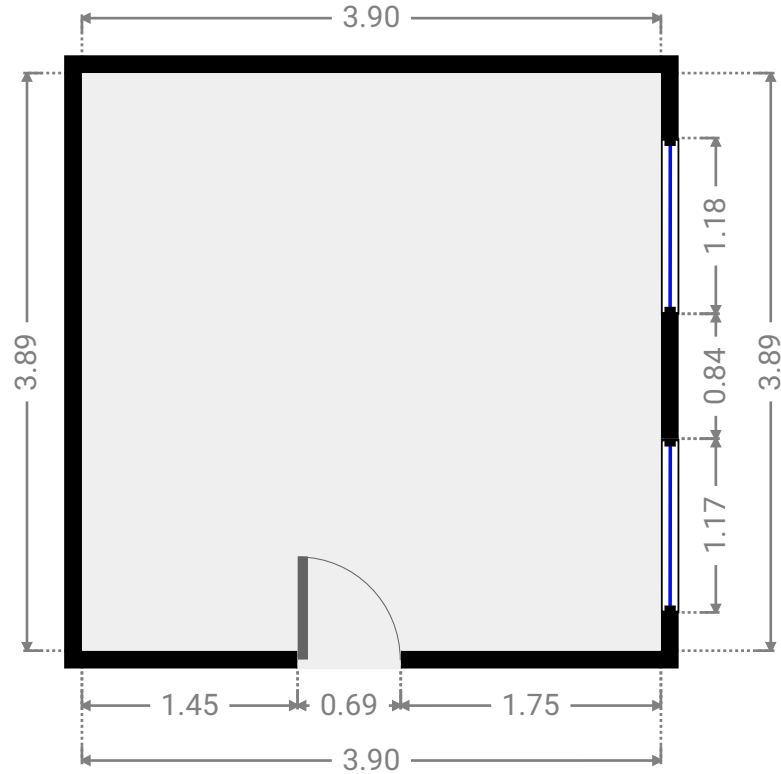
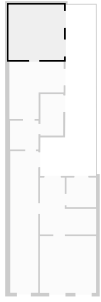

▼ **Bad**  
Erdgeschoss

BREITE: 1.60 m • LÄNGE: 2.92 m • DECKENHÖHE: 3.72 m  
BEREICH: 4.68 m<sup>2</sup> • UMFANG: 9.04 m

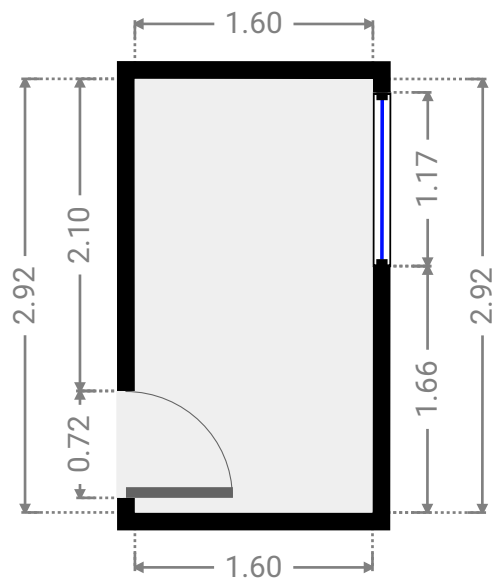
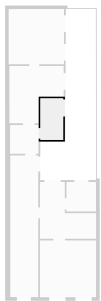

▼ **Hinterhof**  
Erdgeschoss

BREITE: 3.94 m · LÄNGE: 12.07 m · DECKENHÖHE: 3.72 m  
BEREICH: 30.90 m<sup>2</sup> · UMFANG: 31.96 m

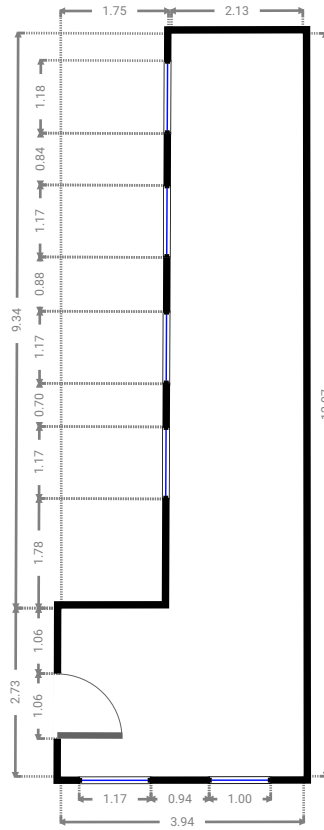
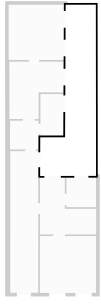

▼ 1. Stock

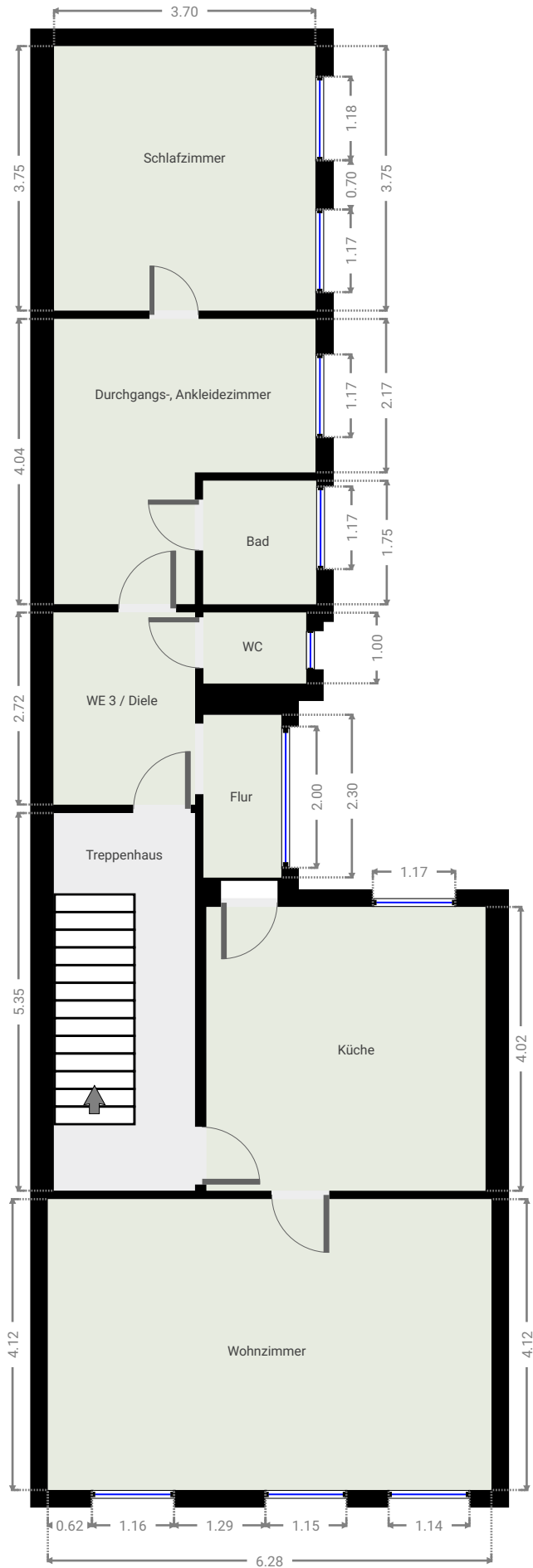

▼ **Treppenhaus**  
1. Stock

BREITE: 2.00 m • LÄNGE: 5.35 m • DECKENHÖHE: 3.41 m  
BEREICH: 10.70 m<sup>2</sup> • UMFANG: 14.70 m

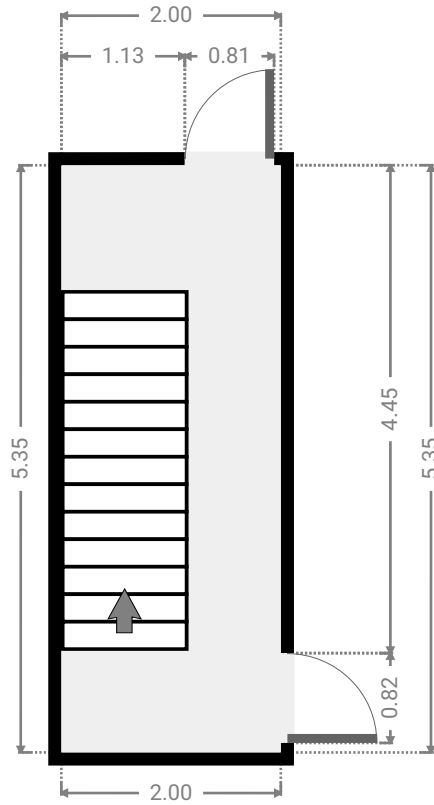

▼ **Wohnzimmer**  
1. Stock

BREITE: 6.28 m • LÄNGE: 4.12 m  
BEREICH: 25.87 m<sup>2</sup> • UMFANG: 20.80 m

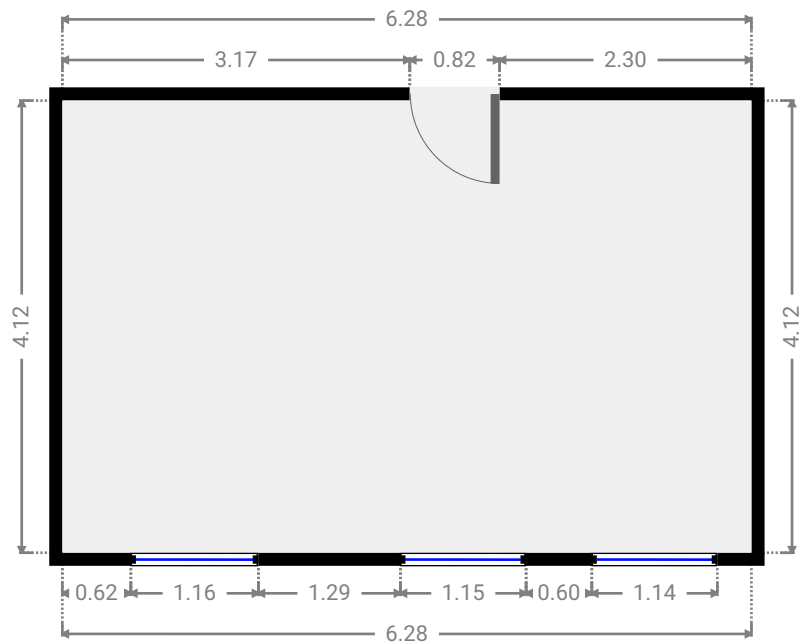

▼ **Küche**  
1. Stock

BREITE: 3.95 m • LÄNGE: 4.02 m  
BEREICH: 15.88 m<sup>2</sup> • UMFANG: 15.94 m

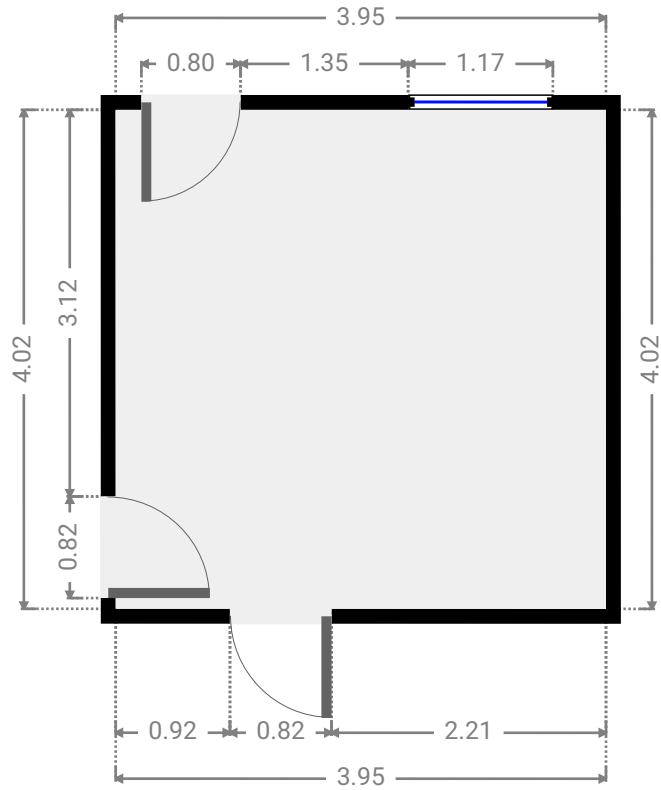
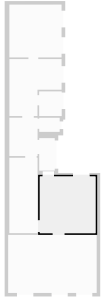

▼ **Flur**  
1. Stock

BREITE: 1.10 m • LÄNGE: 2.30 m  
BEREICH: 2.53 m<sup>2</sup> • UMFANG: 6.81 m

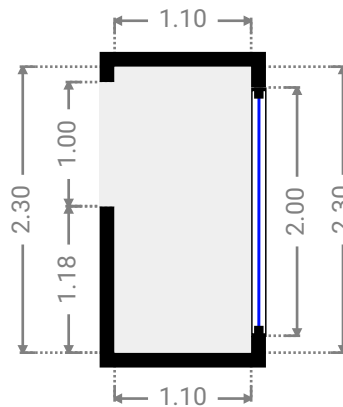
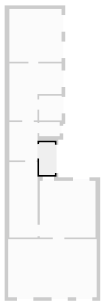

▼ WE 3 / Diele  
1. Stock

BREITE: 2.00 m • LÄNGE: 2.72 m  
BEREICH: 5.44 m<sup>2</sup> • UMFANG: 9.44 m

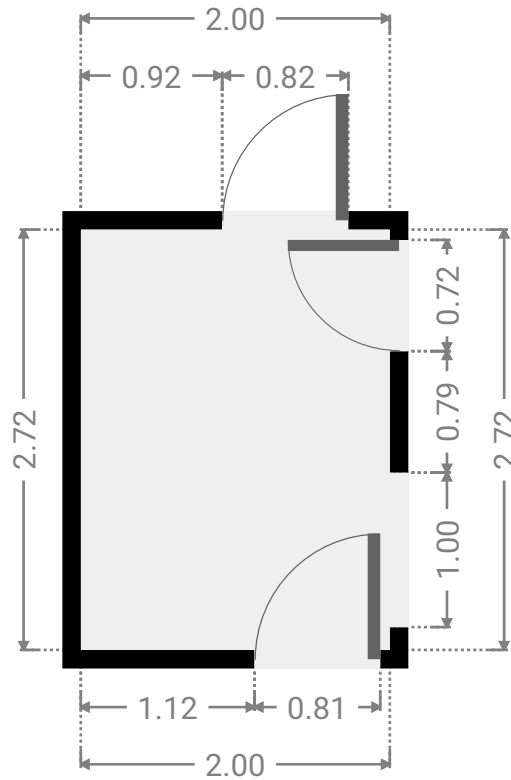
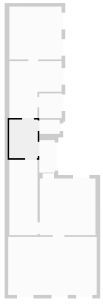

▼ WC  
1. Stock

BREITE: 1.45 m • LÄNGE: 1.00 m  
BEREICH: 1.45 m<sup>2</sup> • UMFANG: 4.90 m

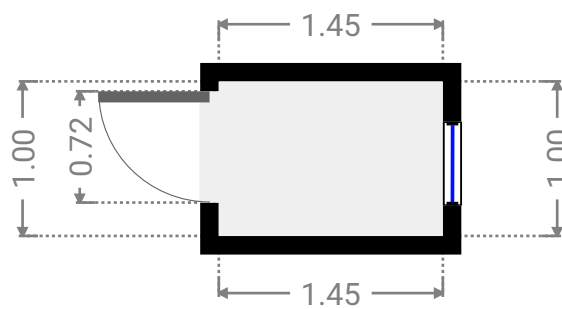

▼ **Bad**  
1. Stock

BREITE: 1.60 m • LÄNGE: 1.75 m  
BEREICH: 2.80 m<sup>2</sup> • UMFANG: 6.70 m

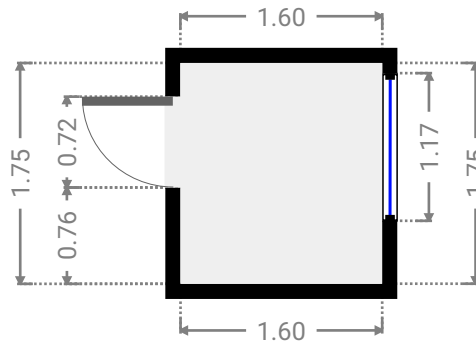
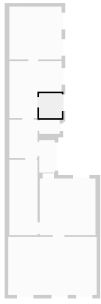

▼ **Durchgangs-, Ankleidezimmer**  
1. Stock

BREITE: 3.70 m • LÄNGE: 4.04 m  
BEREICH: 11.75 m<sup>2</sup> • UMFANG: 15.48 m

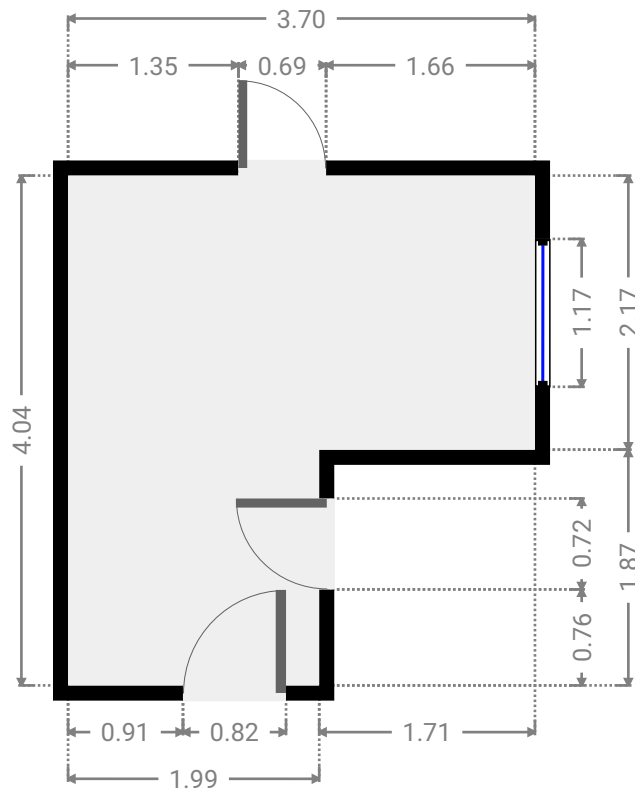

▼ **Schlafzimmer**  
1. Stock

BREITE: 3.70 m • LÄNGE: 3.75 m  
BEREICH: 13.86 m<sup>2</sup> • UMFANG: 14.89 m

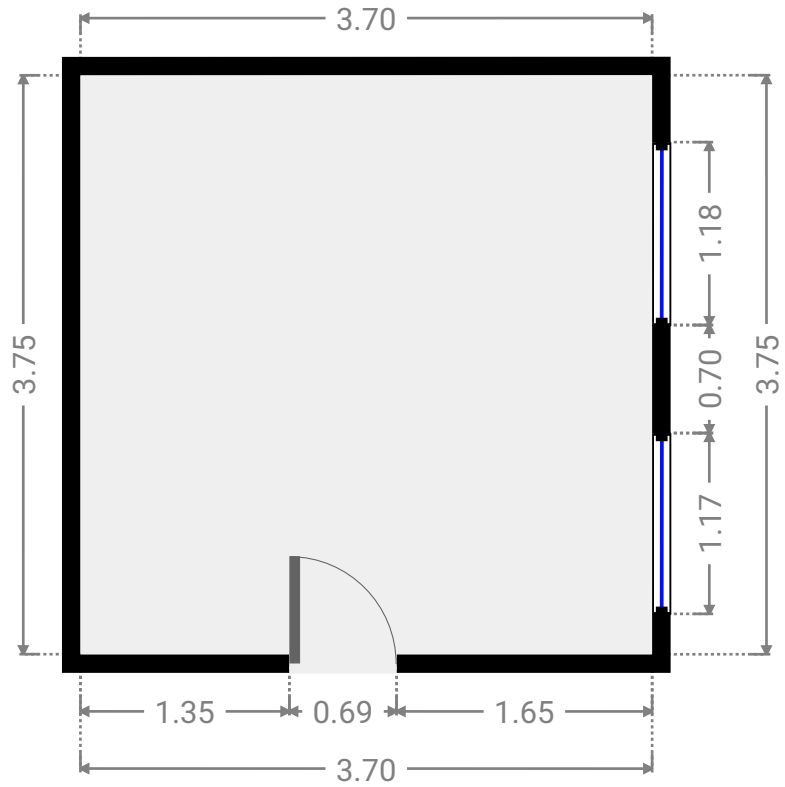

▼ 2. Stock

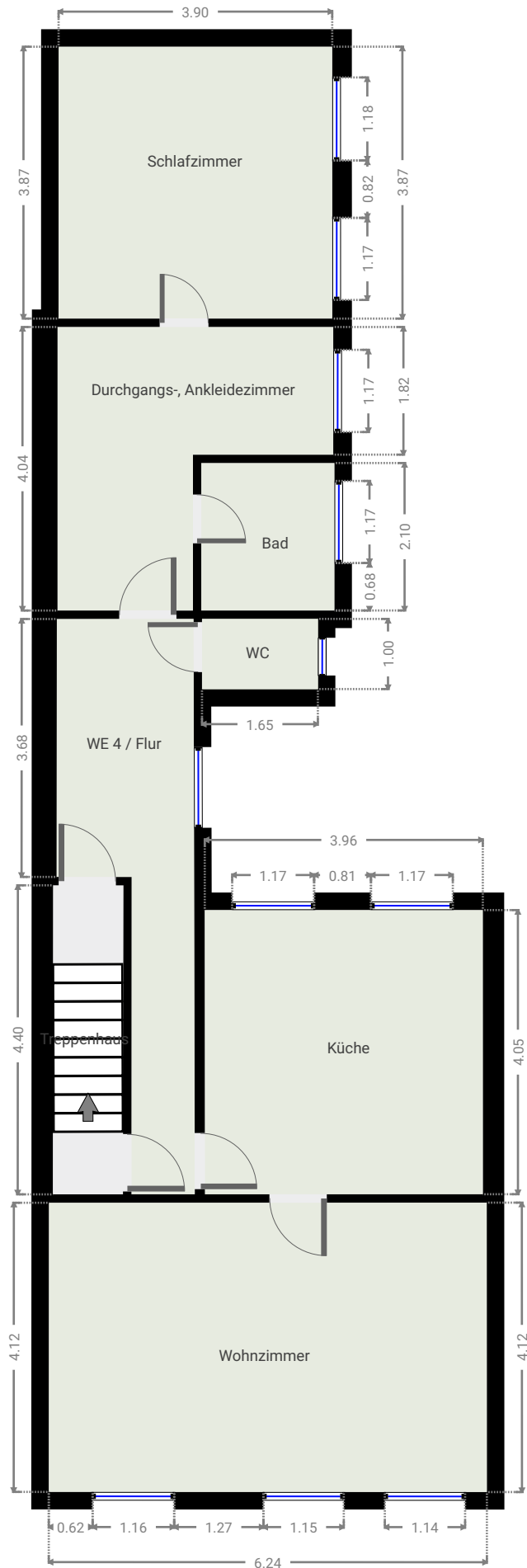

▼ **WE 4 / Flur**  
2. Stock

**BREITE:** 1.97 m • **LÄNGE:** 8.20 m • **DECKENHÖHE:** 2.82 m  
**BEREICH:** 11.24 m<sup>2</sup> • **UMFANG:** 20.32 m

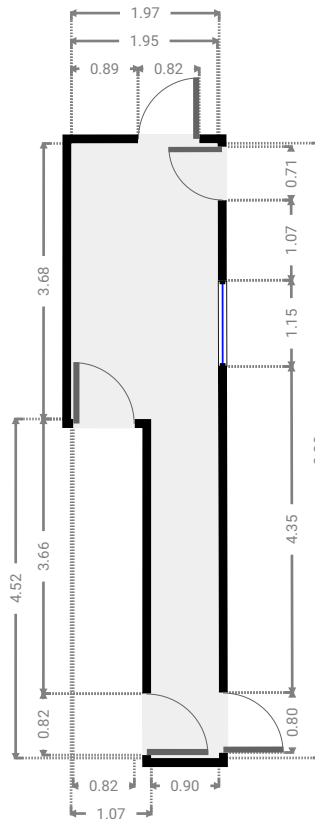
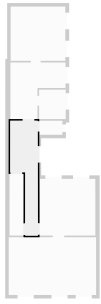

▼ **WC**  
2. Stock

**BREITE:** 1.65 m • **LÄNGE:** 1.00 m • **DECKENHÖHE:** 2.82 m  
**BEREICH:** 1.65 m<sup>2</sup> • **UMFANG:** 5.30 m

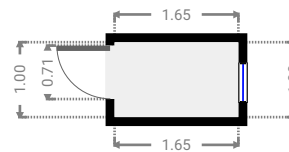

▼ **Durchgangs-, Ankleidezimmer**  
2. Stock

BREITE: 3.93 m • LÄNGE: 4.04 m • DECKENHÖHE: 2.82 m  
BEREICH: 11.44 m<sup>2</sup> • UMFANG: 15.94 m

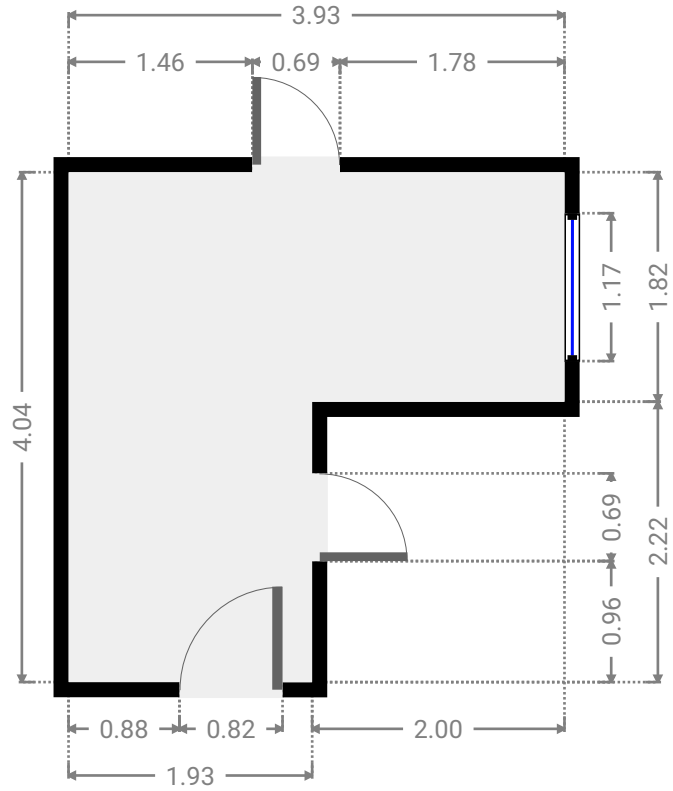

▼ **Bad**  
2. Stock

BREITE: 1.90 m • LÄNGE: 2.10 m • DECKENHÖHE: 2.82 m  
BEREICH: 3.99 m<sup>2</sup> • UMFANG: 8.00 m

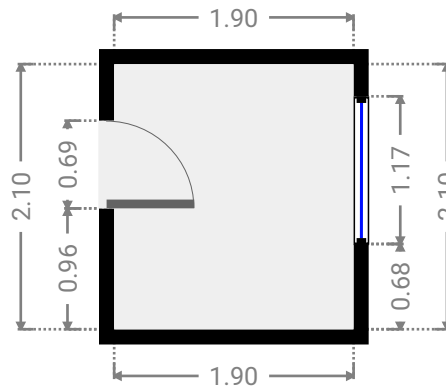
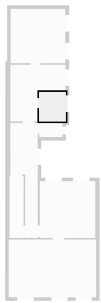

▼ **Schlafzimmer**  
2. Stock

BREITE: 3.90 m • LÄNGE: 3.88 m • DECKENHÖHE: 2.82 m  
BEREICH: 15.12 m<sup>2</sup> • UMFANG: 15.55 m

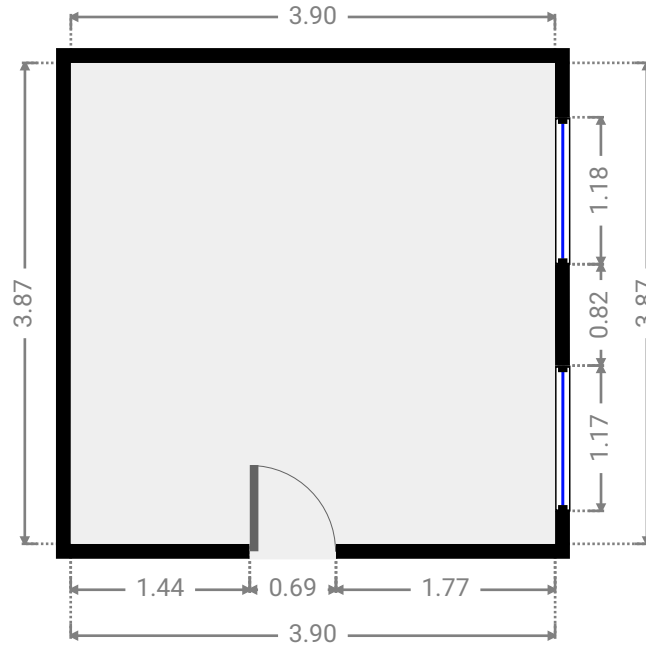

▼ **Küche**  
2. Stock

BREITE: 3.96 m • LÄNGE: 4.05 m • DECKENHÖHE: 2.82 m  
BEREICH: 16.04 m<sup>2</sup> • UMFANG: 16.02 m

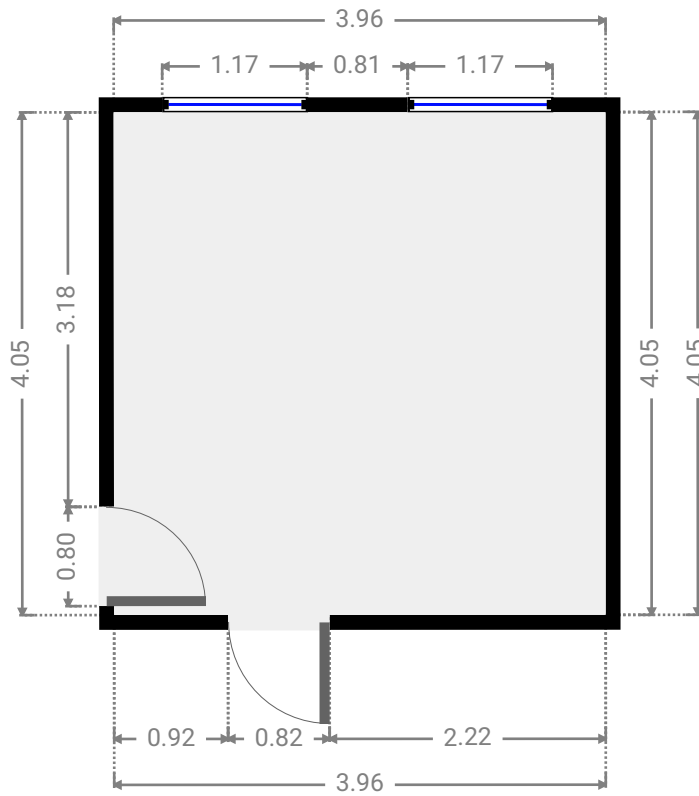
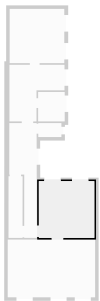

▼ **Wohnzimmer**  
2. Stock

BREITE: 6.24 m • LÄNGE: 4.12 m • DECKENHÖHE: 2.82 m  
BEREICH: 25.73 m<sup>2</sup> • UMFANG: 20.73 m

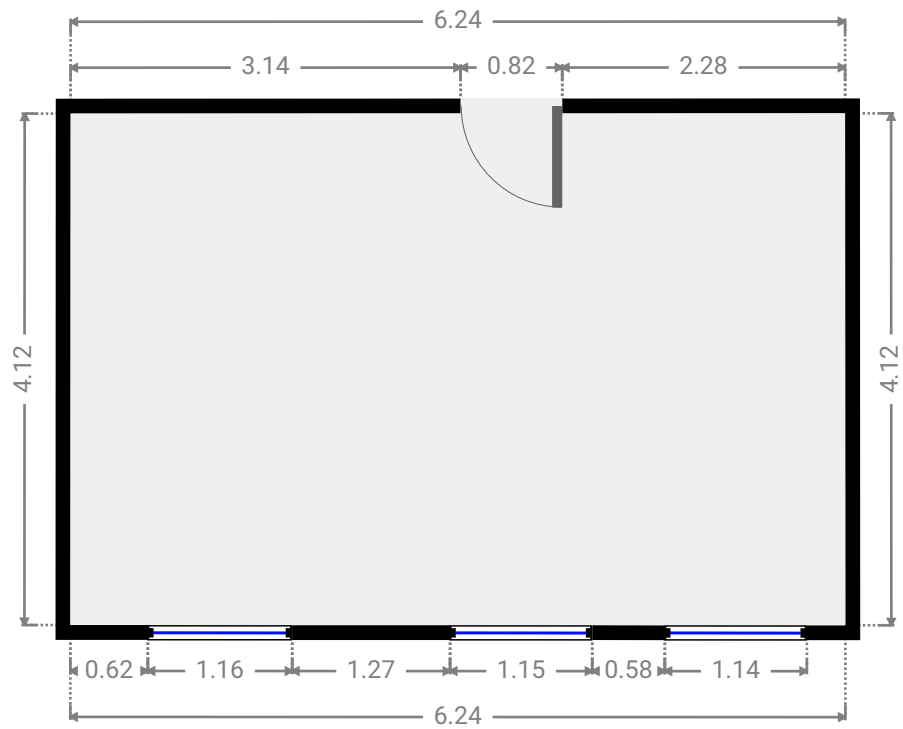

▼ **Treppenhaus**  
2. Stock

BREITE: 1.00 m • LÄNGE: 4.40 m • DECKENHÖHE: 2.82 m  
BEREICH: 4.41 m<sup>2</sup> • UMFANG: 10.81 m

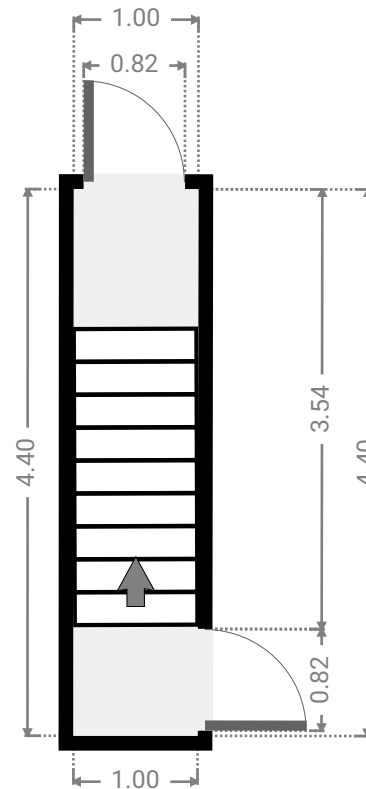

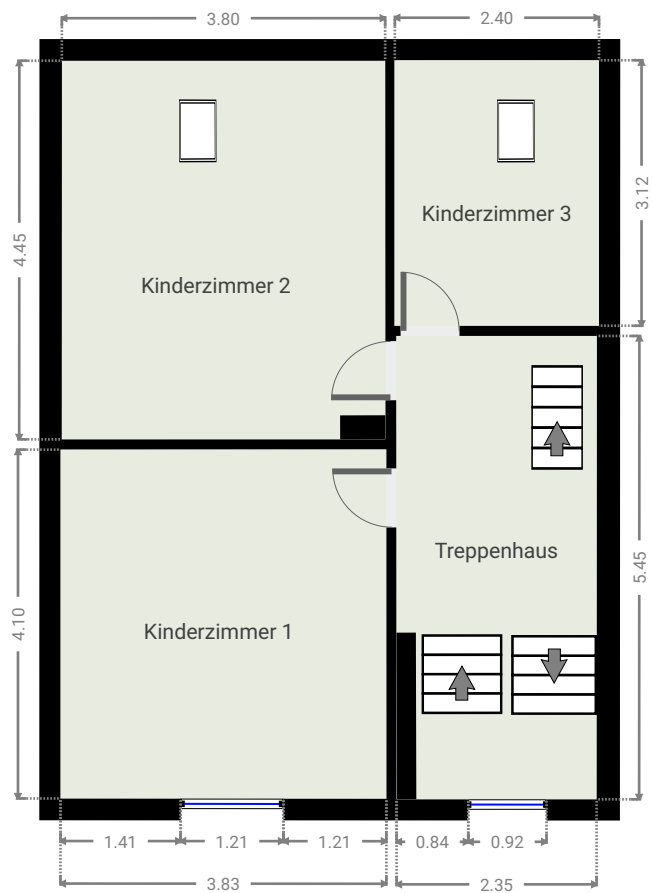

▼ **Treppenhaus**  
Dach

BREITE: 2.36 m • LÄNGE: 5.45 m • DECKENHÖHE: 2.28 m  
BEREICH: 12.82 m<sup>2</sup> • UMFANG: 15.60 m

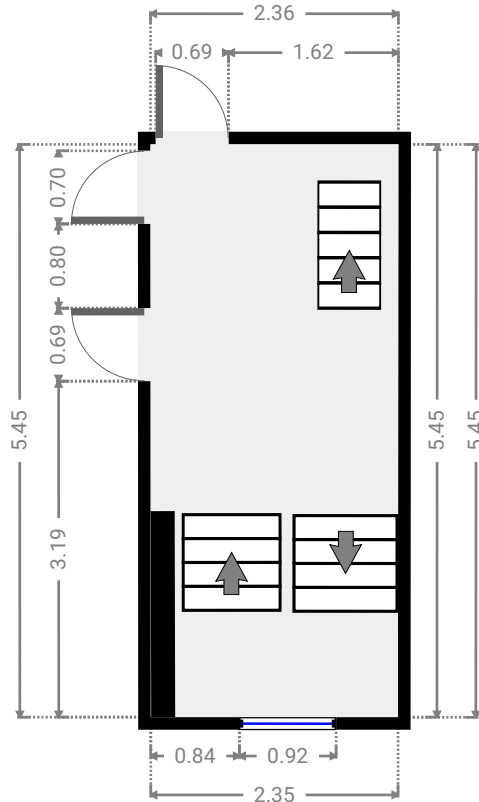
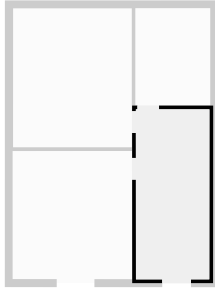

▼ **Kinderzimmer 3**  
Dach

BREITE: 2.40 m • LÄNGE: 3.12 m  
BEREICH: 7.49 m<sup>2</sup> • UMFANG: 11.04 m

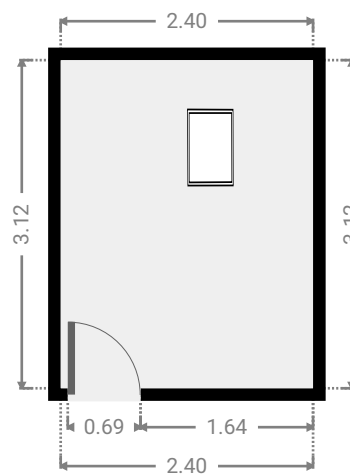
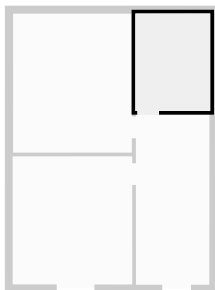

▼ **Kinderzimmer 2**  
Dach

BREITE: 3.80 m • LÄNGE: 4.45 m  
BEREICH: 16.92 m<sup>2</sup> • UMFANG: 16.50 m

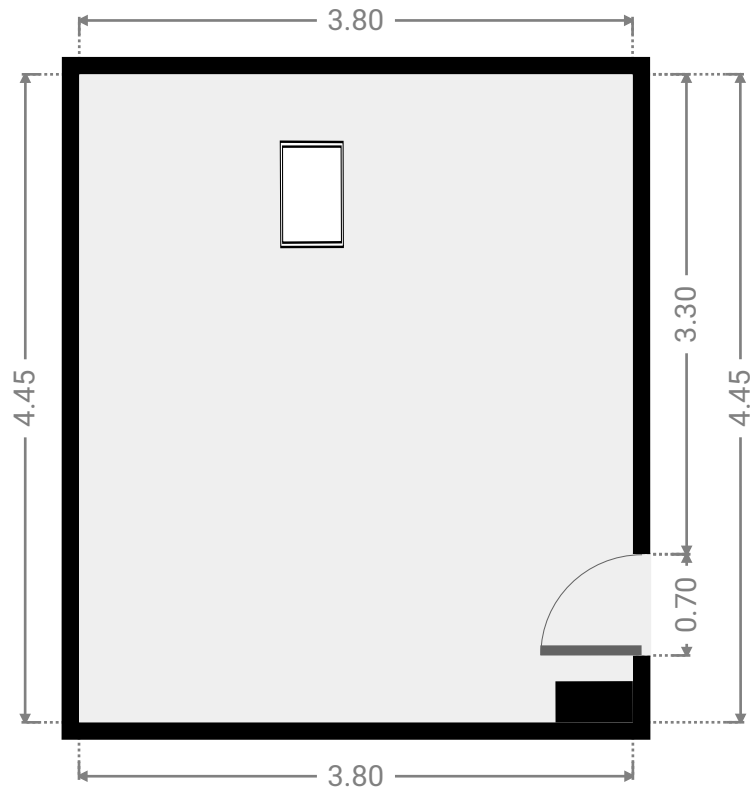
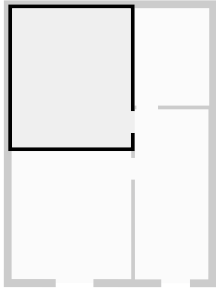

▼ **Kinderzimmer 1**  
Dach

BREITE: 3.83 m • LÄNGE: 4.10 m  
BEREICH: 15.71 m<sup>2</sup> • UMFANG: 15.87 m

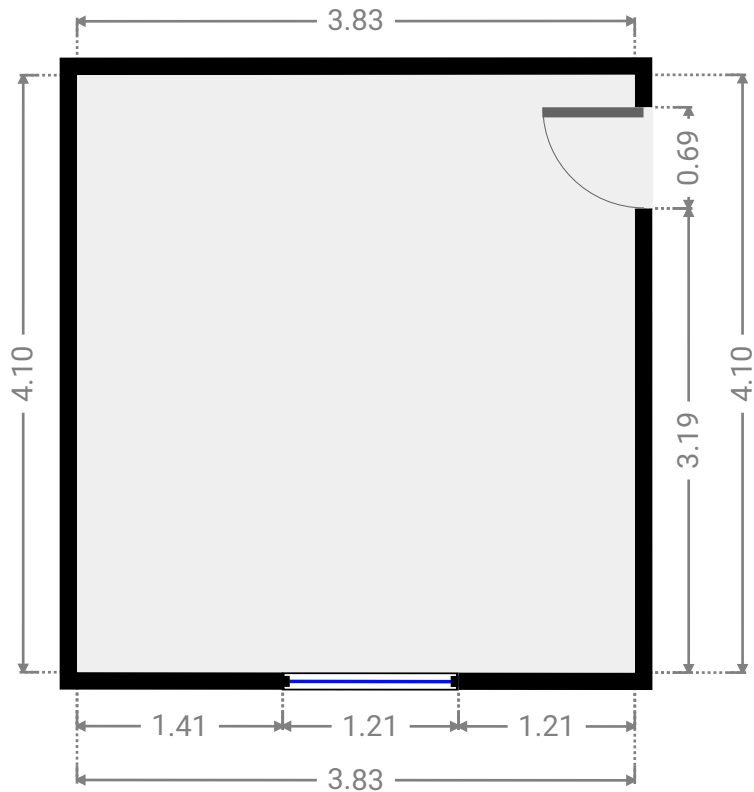
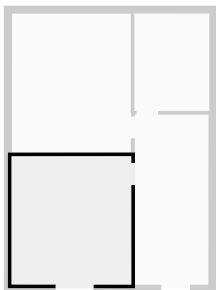

*J. Jann*  
**LIGHTSCAN**  
ECHT VERMESSEN  
Thomas Menn  
Steinstr. 4 • 57072 Siegen  
☎ 01 76 - 43 21 99 05  
✉ info@lightscan.de

Siegen, den 12.07.2021