

Sachverständigenbüro

Thomas Lennier
Vehrter Landstraße 256
49088 Osnabrück
Steuernummer: 66/126/04771

thomas.lennier@gmx.de

Grundriss für das
Mehrfamilienhaus mit 8 Wohneinheiten,
Max-Reger-Weg 17, 33100 Paderborn

Durchgeführt am 08.12.2025

Osnabrück, den 08.12.2025



08.12.25

T. 

▼ Erdgeschoss

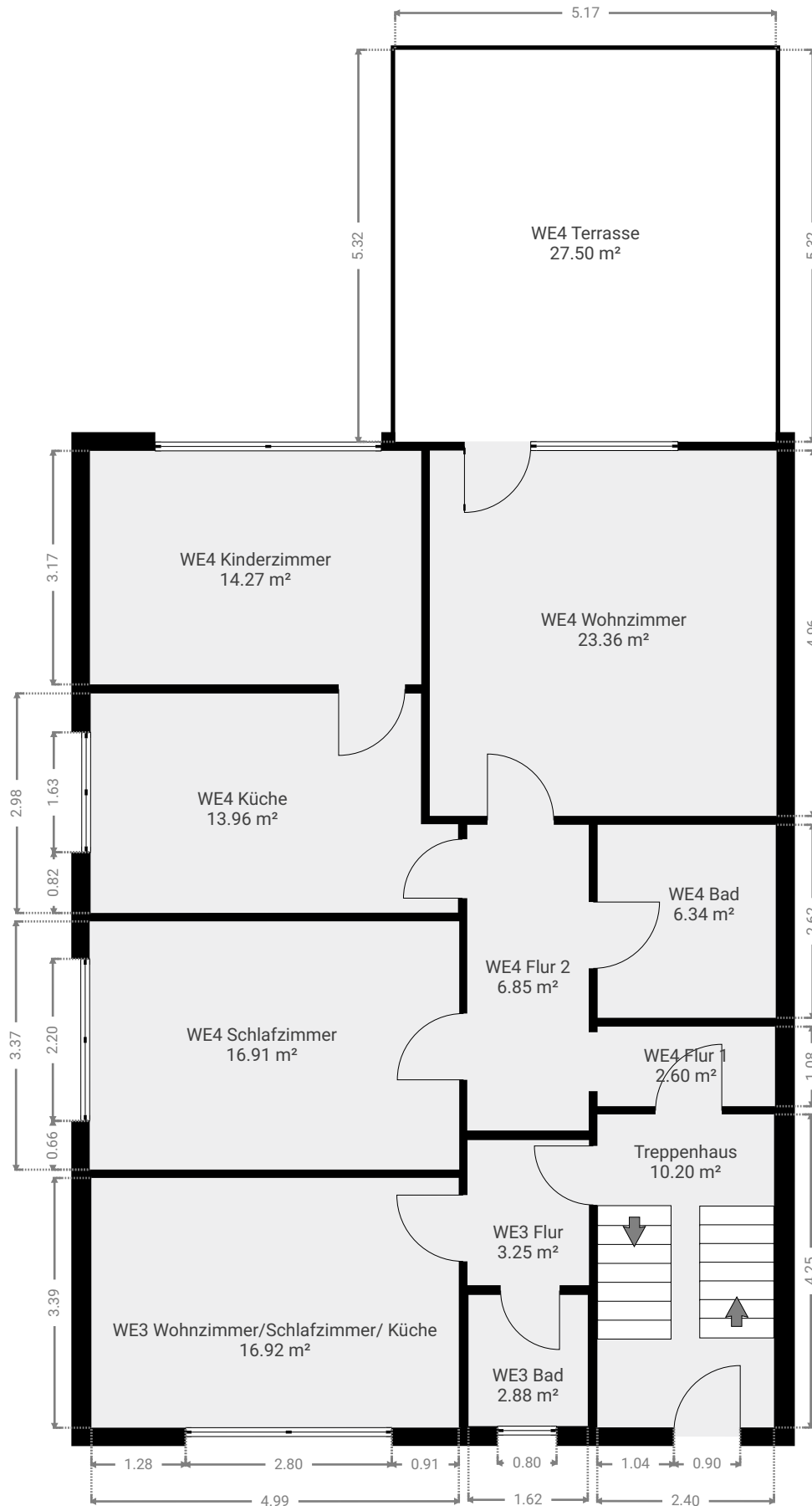

ETAGEN: 4

▼ **Treppenhaus**
Erdgeschoss

BREITE: 2.40 m • LÄNGE: 4.25 m
BEREICH: 10.20 m² • UMFANG: 13.30 m

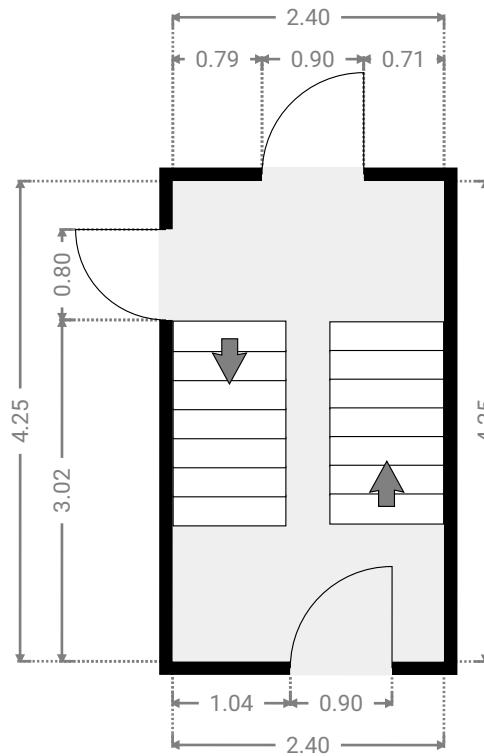
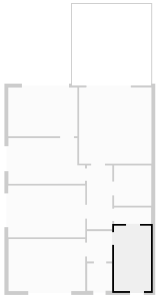

▼ **WE3 Bad**
Erdgeschoss

BREITE: 1.62 m • LÄNGE: 1.78 m
BEREICH: 2.88 m² • UMFANG: 6.80 m

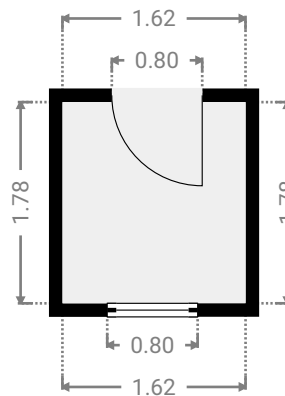
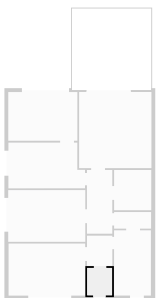

ETAGEN: 4

▼ **WE3 Flur**
Erdgeschoss

BREITE: 1.65 m • LÄNGE: 1.97 m
BEREICH: 3.25 m² • UMFANG: 7.24 m

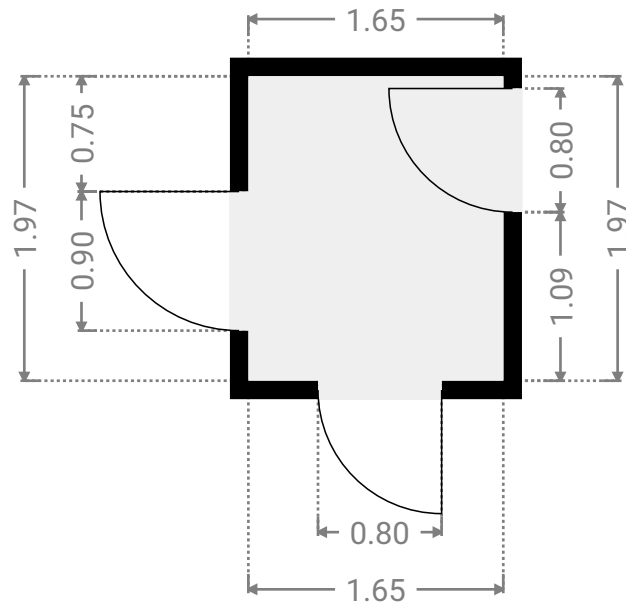
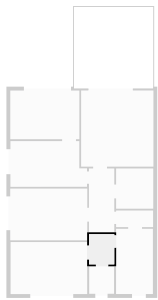

▼ **WE3 Wohnzimmer/Schlafzimmer/ Küche**
Erdgeschoss

BREITE: 4.99 m • LÄNGE: 3.39 m
BEREICH: 16.92 m² • UMFANG: 16.76 m

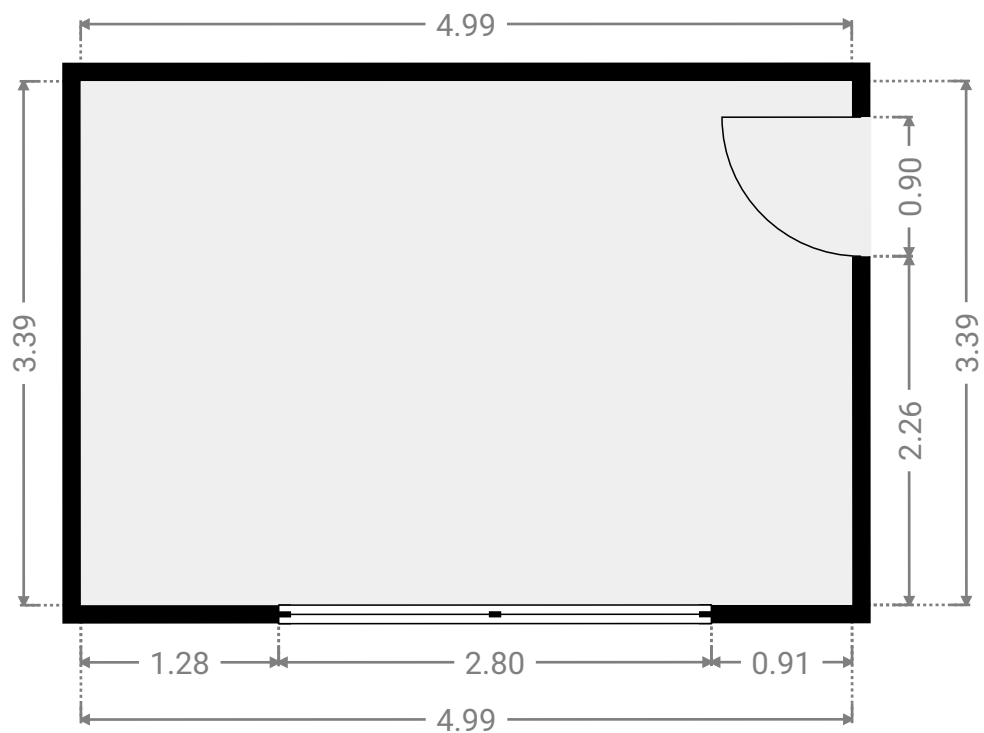
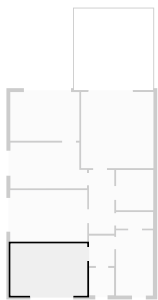

ETAGEN: 4

▼ **WE4 Bad**
Erdgeschoss

BREITE: 2.42 m • LÄNGE: 2.62 m
BEREICH: 6.34 m² • UMFANG: 10.08 m

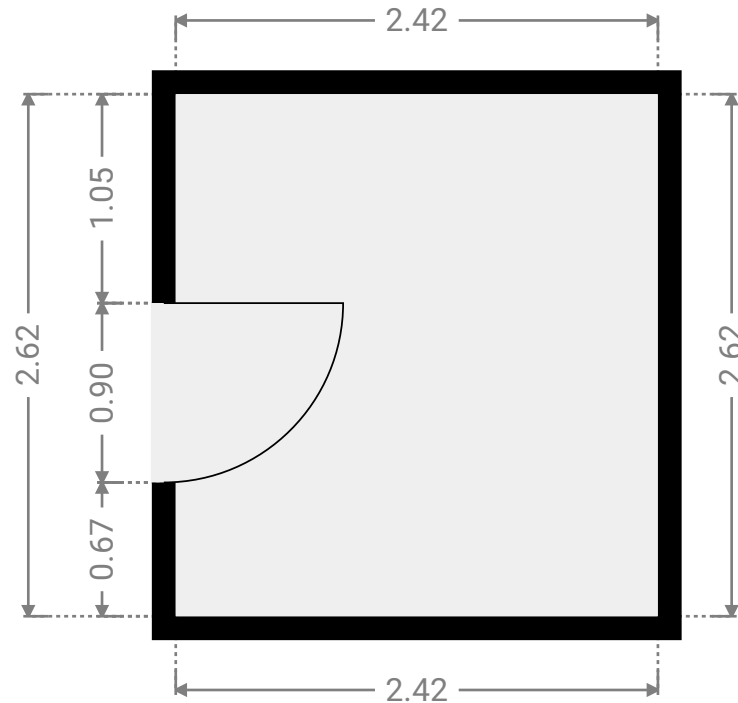
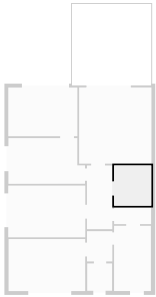

▼ **WE4 Flur 1**
Erdgeschoss

BREITE: 2.41 m • LÄNGE: 1.08 m
BEREICH: 2.60 m² • UMFANG: 6.98 m

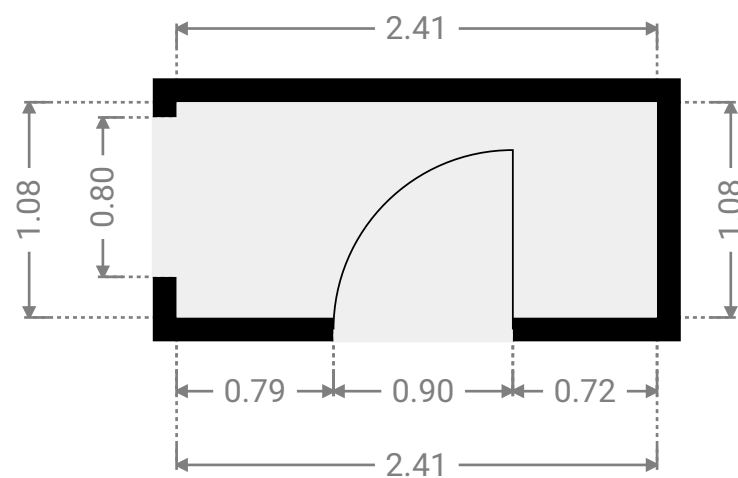
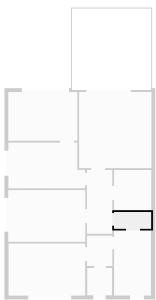

ETAGEN: 4

▼ **WE4 Flur 2**
Erdgeschoss

BREITE: 1.65 m • LÄNGE: 4.15 m
BEREICH: 6.85 m² • UMFANG: 11.60 m

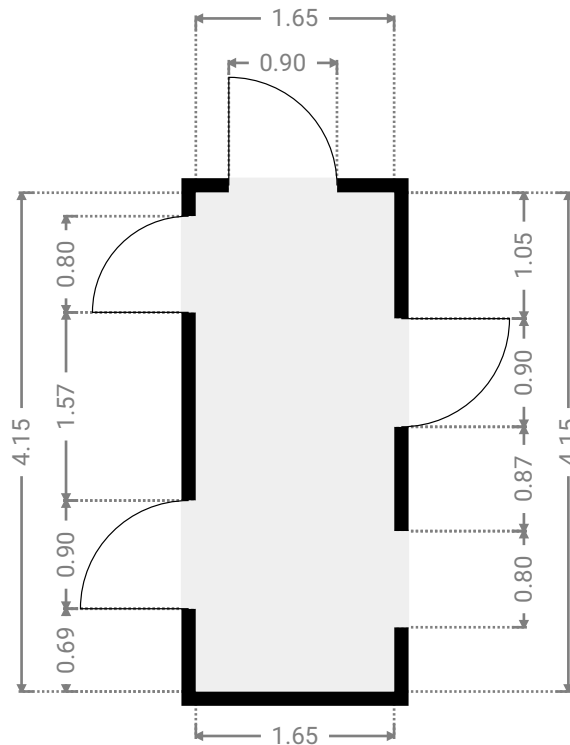
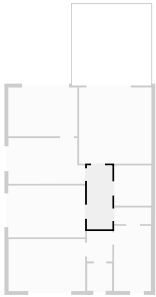

▼ **WE4 Kinderzimmer**
Erdgeschoss

BREITE: 4.50 m • LÄNGE: 3.17 m
BEREICH: 14.27 m² • UMFANG: 15.34 m

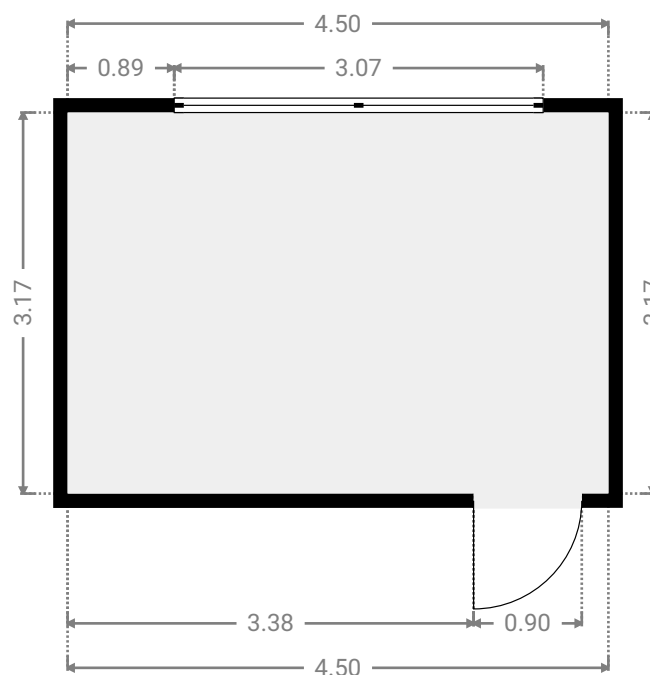
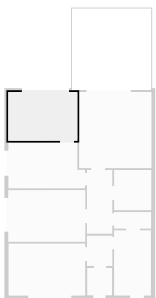

ETAGEN: 4

▼ **WE4 Küche**
Erdgeschoss

BREITE: 4.99 m • LÄNGE: 2.98 m
BEREICH: 13.96 m² • UMFANG: 15.93 m

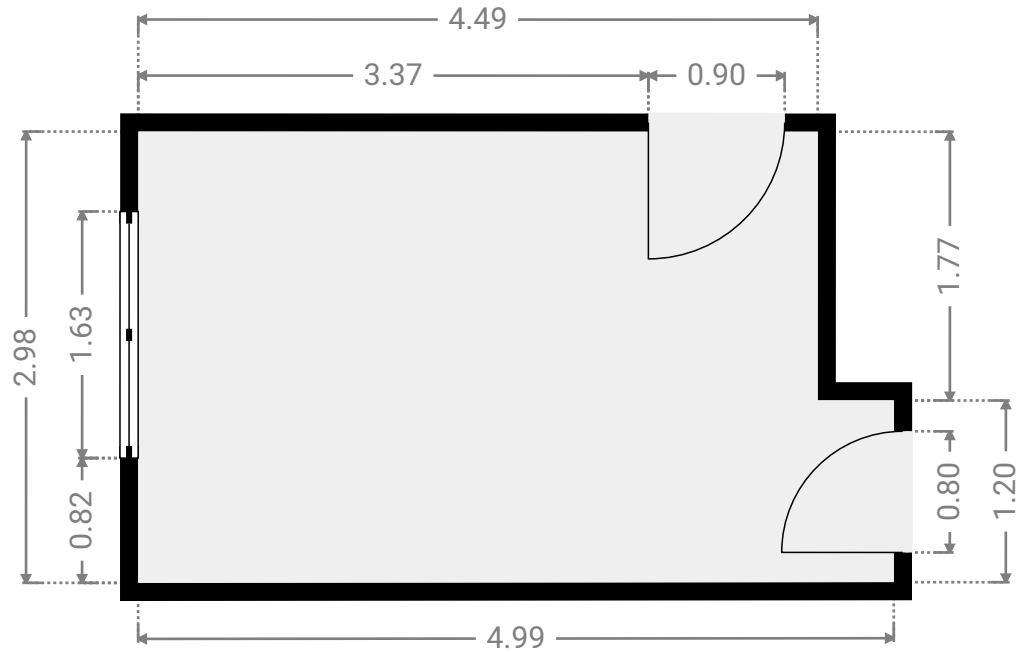
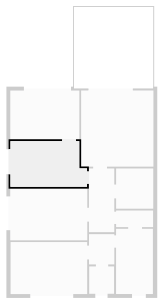

▼ **WE4 Schlafzimmer**
Erdgeschoss

BREITE: 5.02 m • LÄNGE: 3.37 m
BEREICH: 16.91 m² • UMFANG: 16.78 m

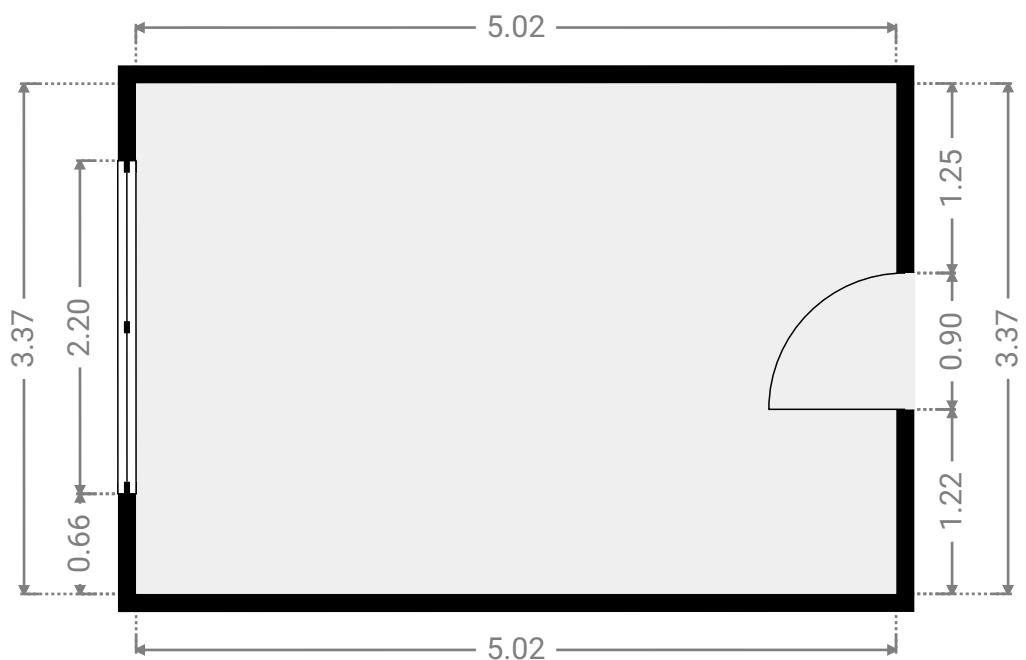
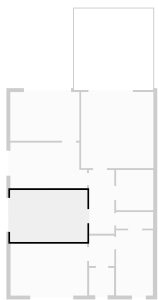

ETAGEN: 4

▼ **WE4 Wohnzimmer**
Erdgeschoss

BREITE: 4.71 m · LÄNGE: 4.96 m
BEREICH: 23.36 m² · UMFANG: 19.34 m

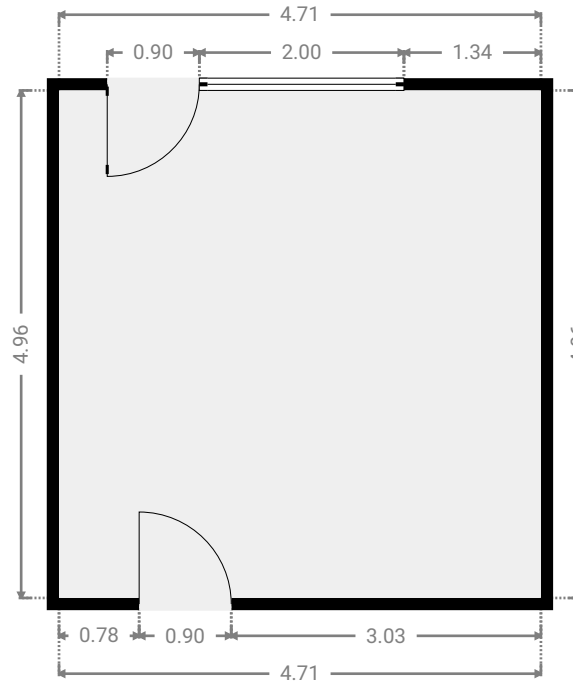
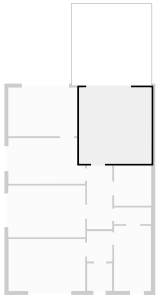

▼ **WE4 Terrasse**
Erdgeschoss

BREITE: 5.17 m · LÄNGE: 5.32 m
BEREICH: 27.50 m² · UMFANG: 20.98 m

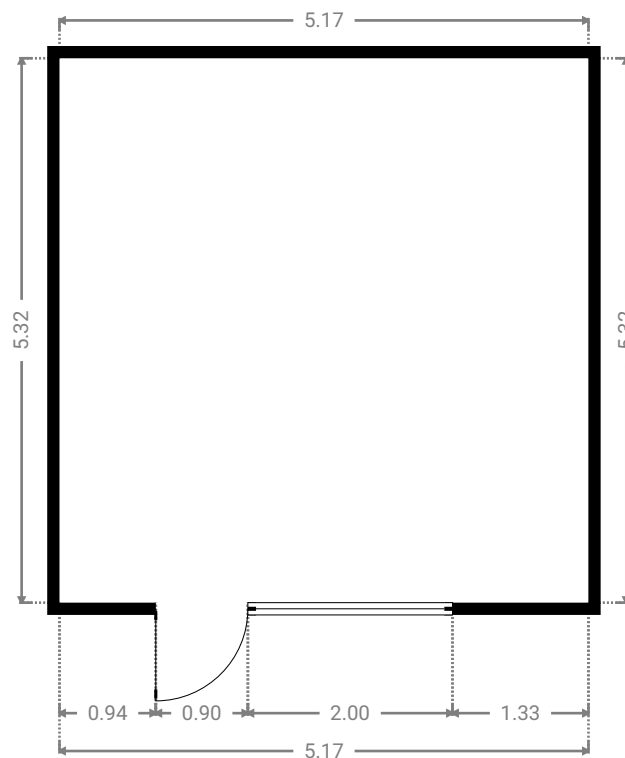
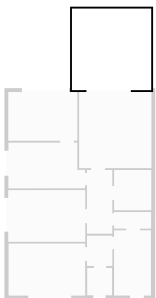

▼ 1. Obergeschoss

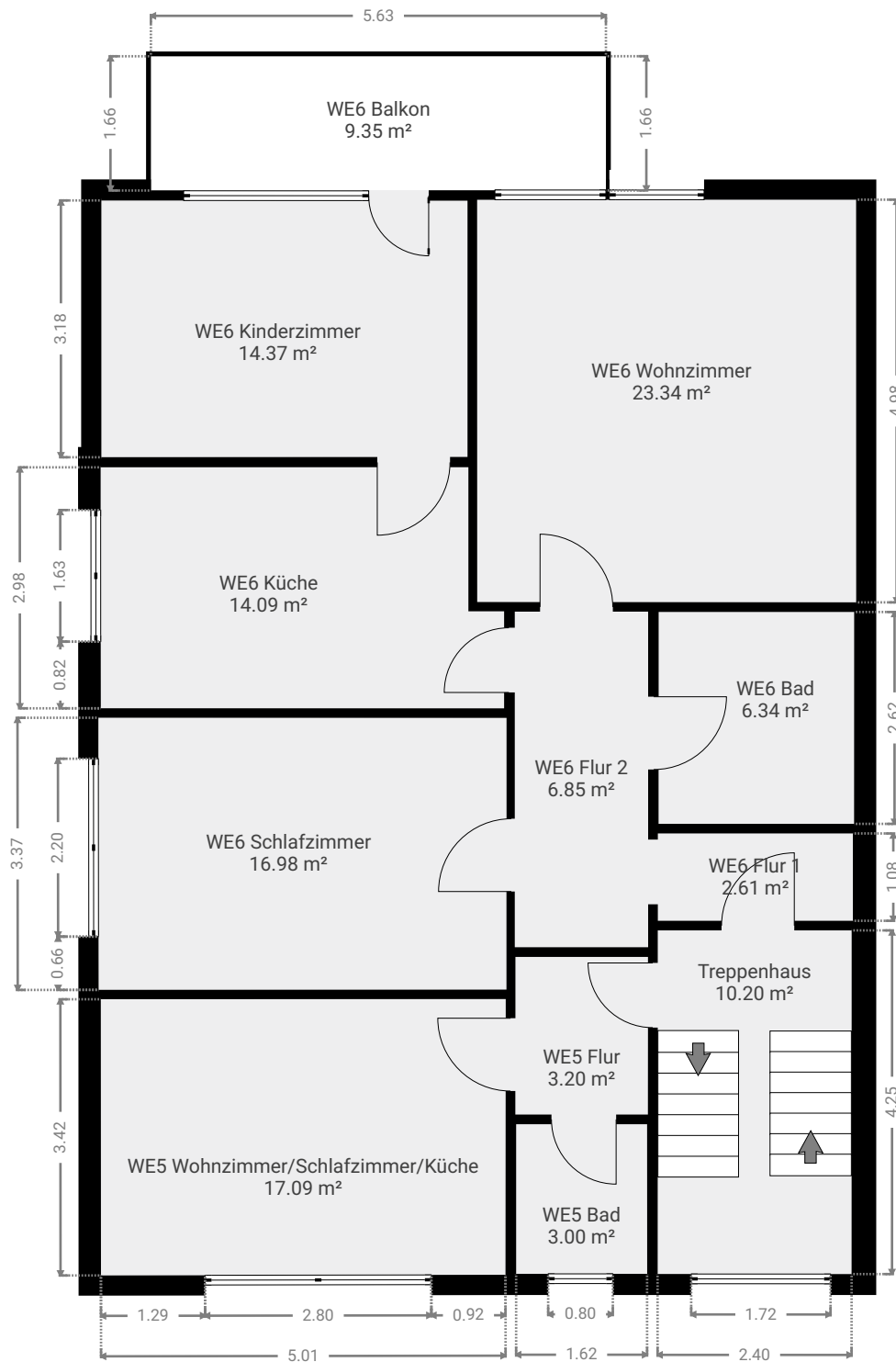

ETAGEN: 4

▼ **Treppenhaus**
1. Obergeschoss

BREITE: 2.40 m • LÄNGE: 4.25 m
BEREICH: 10.20 m² • UMFANG: 13.30 m

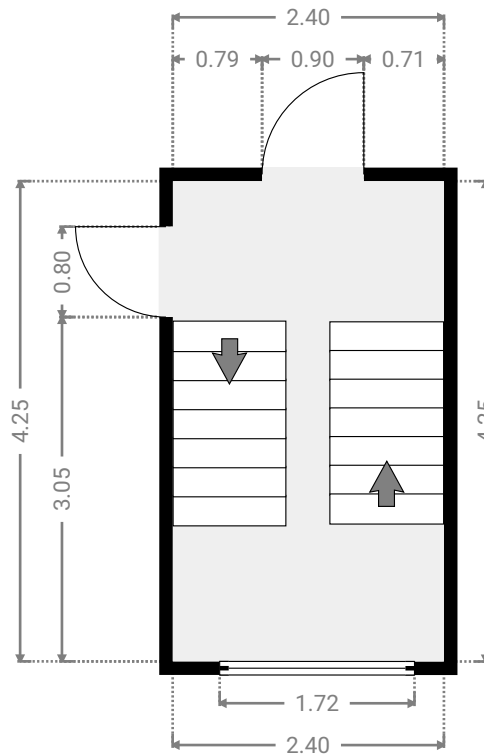
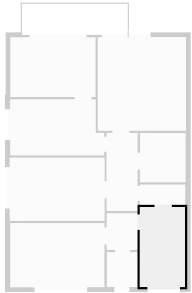

▼ **WE5 Bad**
1. Obergeschoss

BREITE: 1.62 m • LÄNGE: 1.85 m
BEREICH: 3.00 m² • UMFANG: 6.94 m

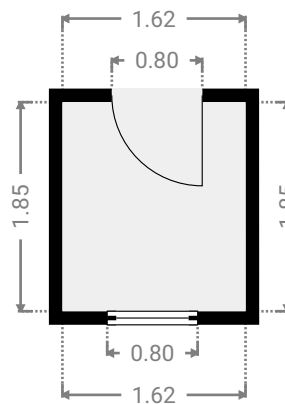
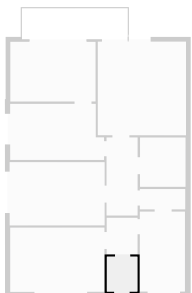

ETAGEN: 4

▼ **WE5 Flur**
1. Obergeschoss

BREITE: 1.64 m • LÄNGE: 1.95 m
BEREICH: 3.20 m² • UMFANG: 7.18 m

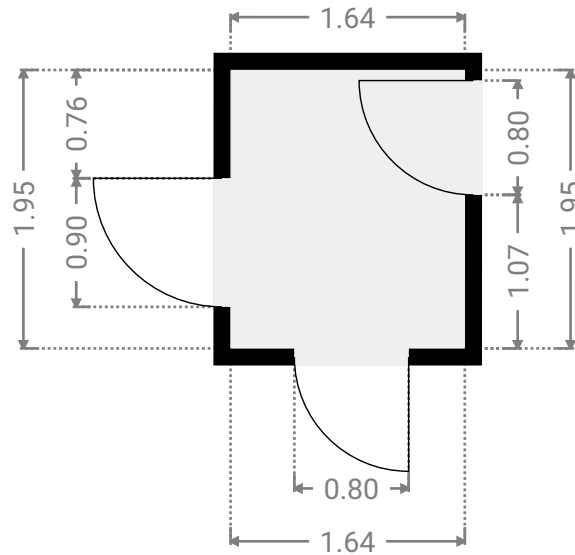
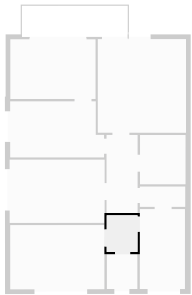

▼ **WE5 Wohnzimmer/Schlafzimmer/Küche**
1. Obergeschoss

BREITE: 5.01 m • LÄNGE: 3.42 m
BEREICH: 17.09 m² • UMFANG: 16.84 m

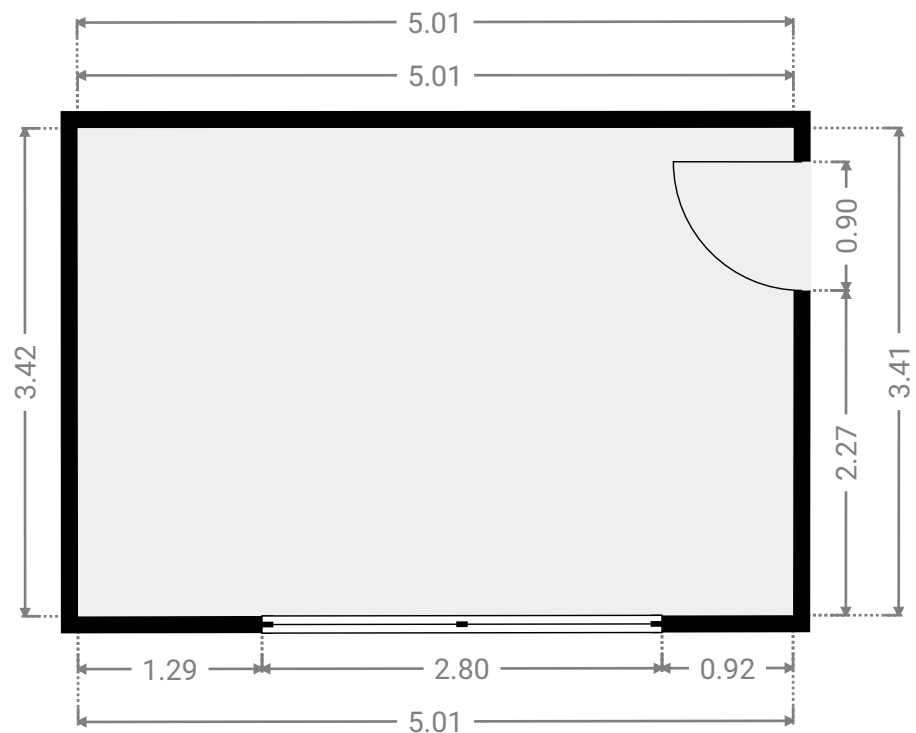
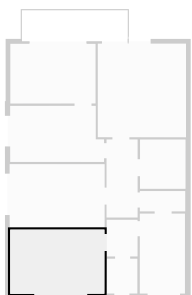

ETAGEN: 4

▼ **WE6 Bad**
1. Obergeschoss

BREITE: 2.42 m • LÄNGE: 2.62 m
BEREICH: 6.34 m² • UMFANG: 10.08 m

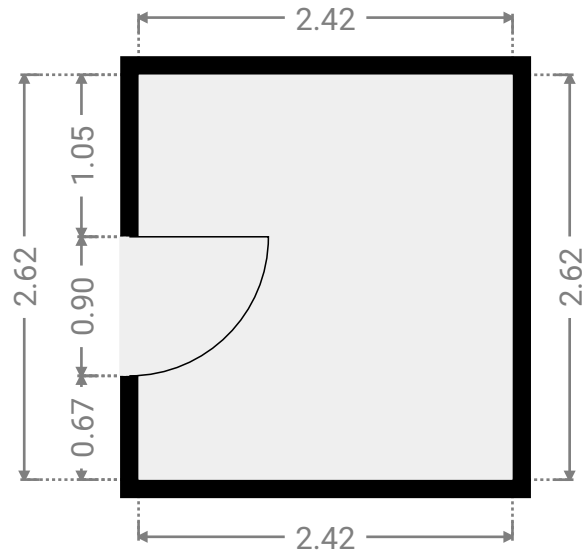
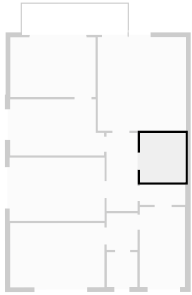

▼ **WE6 Balkon**
1. Obergeschoss

BREITE: 5.63 m • LÄNGE: 1.66 m
BEREICH: 9.35 m² • UMFANG: 14.58 m

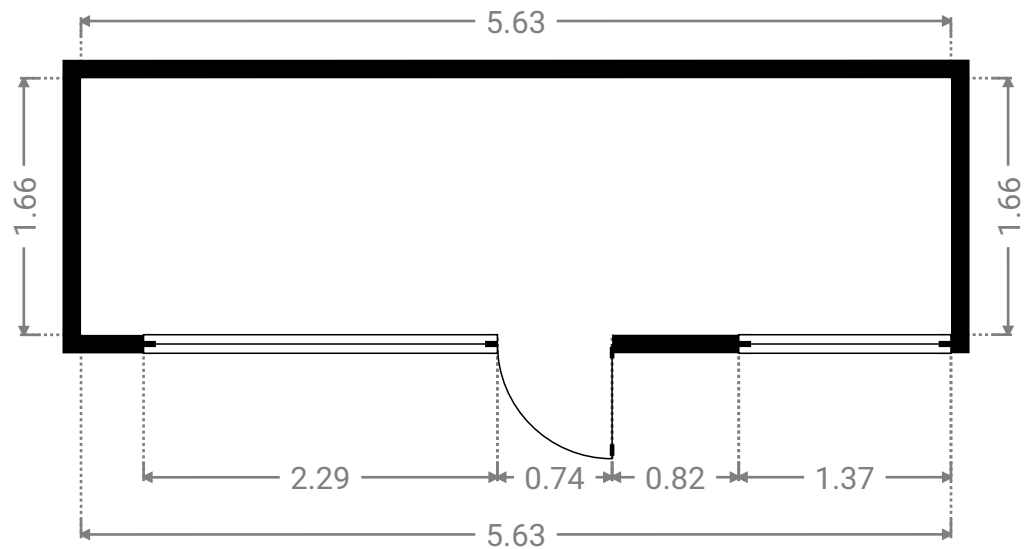
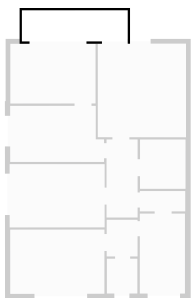

ETAGEN: 4

▼ **WE6 Flur 1**
1. Obergeschoss

BREITE: 2.41 m · LÄNGE: 1.08 m
BEREICH: 2.61 m² · UMFANG: 6.99 m

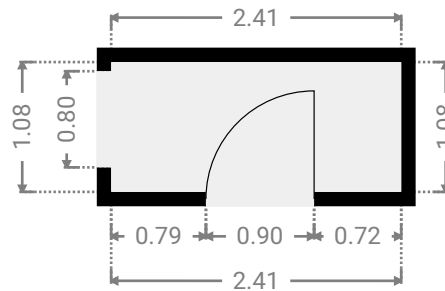
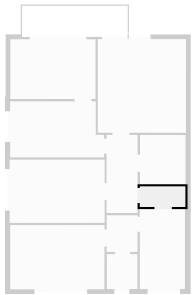

▼ **WE6 Flur 2**
1. Obergeschoss

BREITE: 1.65 m · LÄNGE: 4.15 m
BEREICH: 6.85 m² · UMFANG: 11.60 m

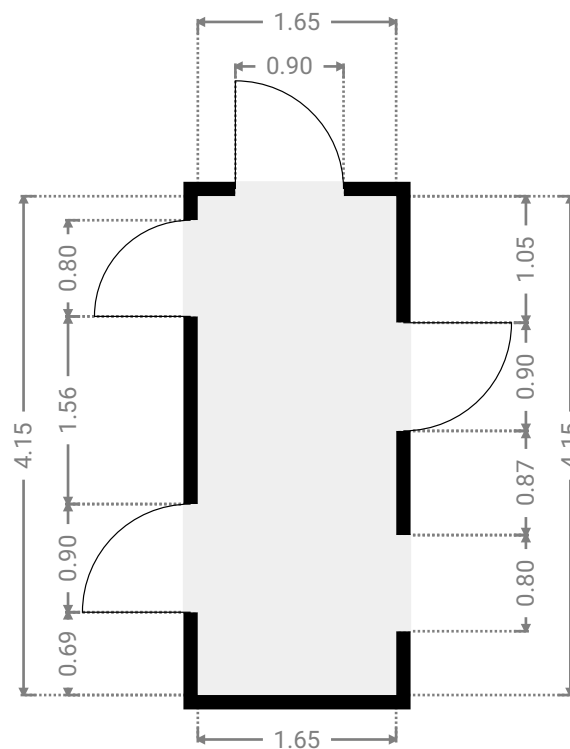
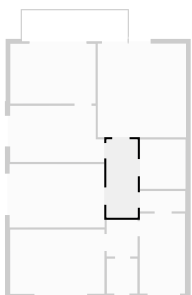

ETAGEN: 4

▼ **WE6 Kinderzimmer**
1. Obergeschoss

BREITE: 4.53 m · LÄNGE: 3.18 m
BEREICH: 14.37 m² · UMFANG: 15.41 m

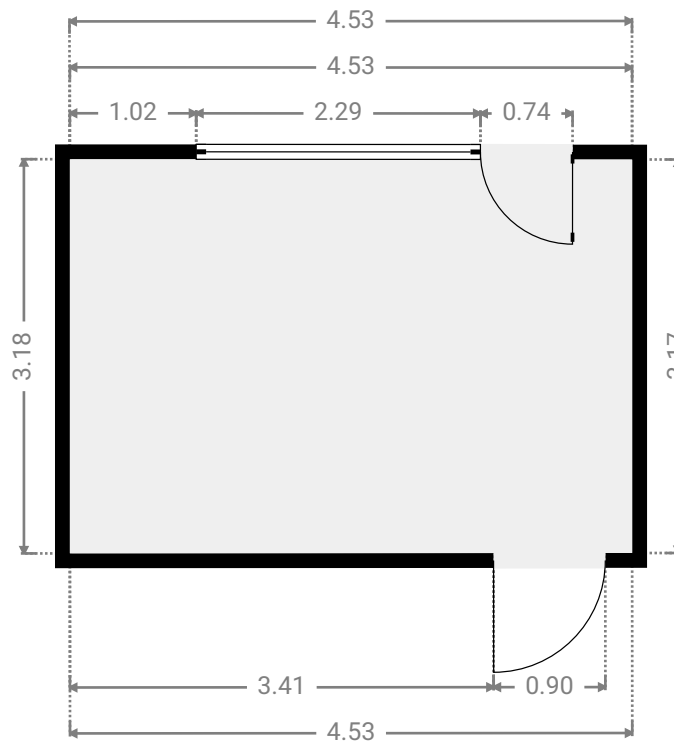
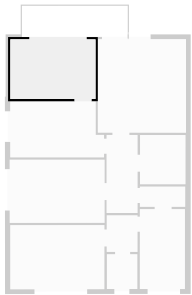

▼ **WE6 Küche**
1. Obergeschoss

BREITE: 4.99 m · LÄNGE: 2.98 m
BEREICH: 14.09 m² · UMFANG: 15.94 m

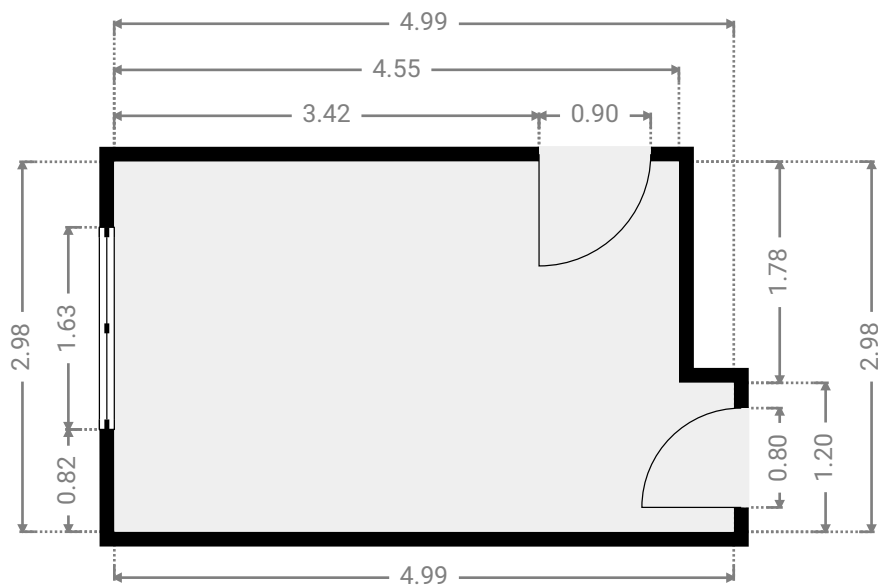
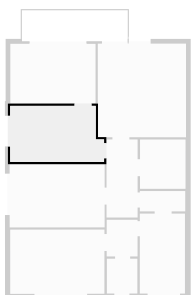

ETAGEN: 4

▼ **WE6 Schlafzimmer**
1. Obergeschoss

BREITE: 5.05 m • LÄNGE: 3.37 m
BEREICH: 16.98 m² • UMFANG: 16.82 m

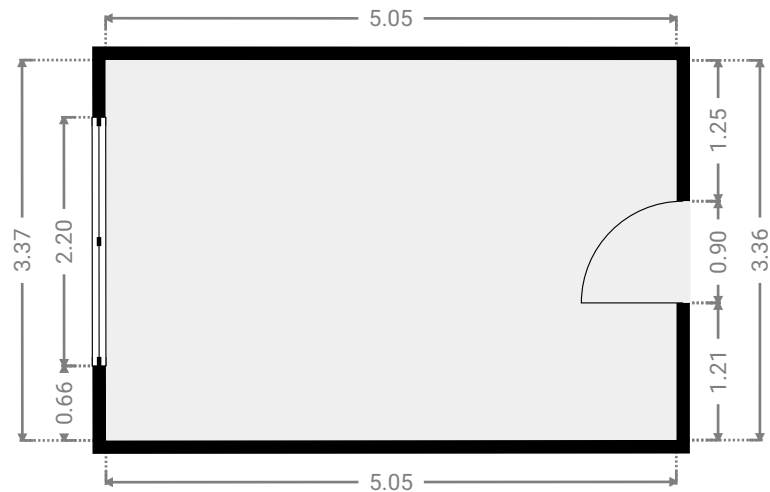
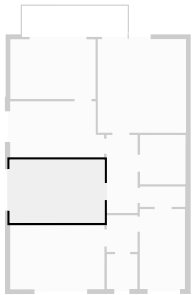

▼ **WE6 Wohnzimmer**
1. Obergeschoss

BREITE: 4.69 m • LÄNGE: 4.98 m
BEREICH: 23.34 m² • UMFANG: 19.34 m

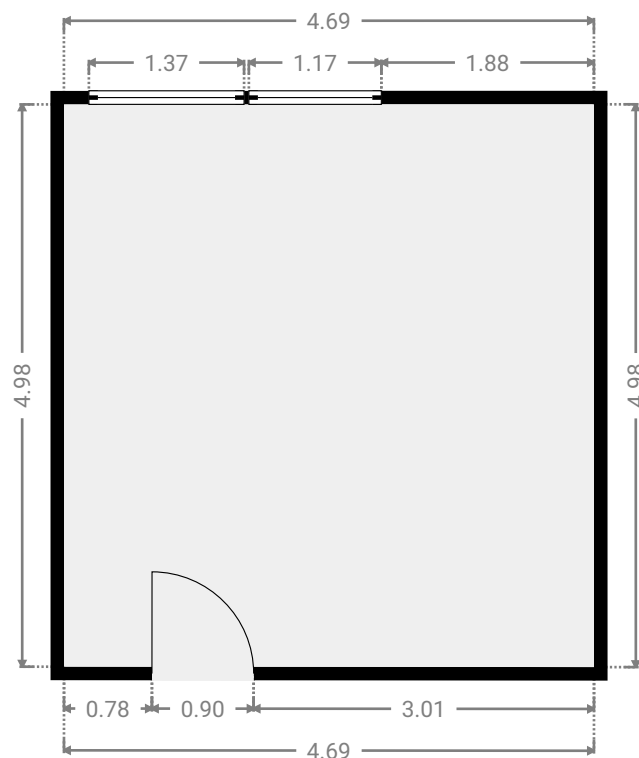
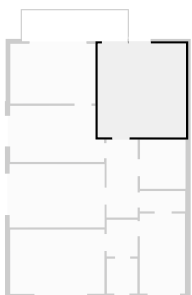

▼ Dachgeschoss

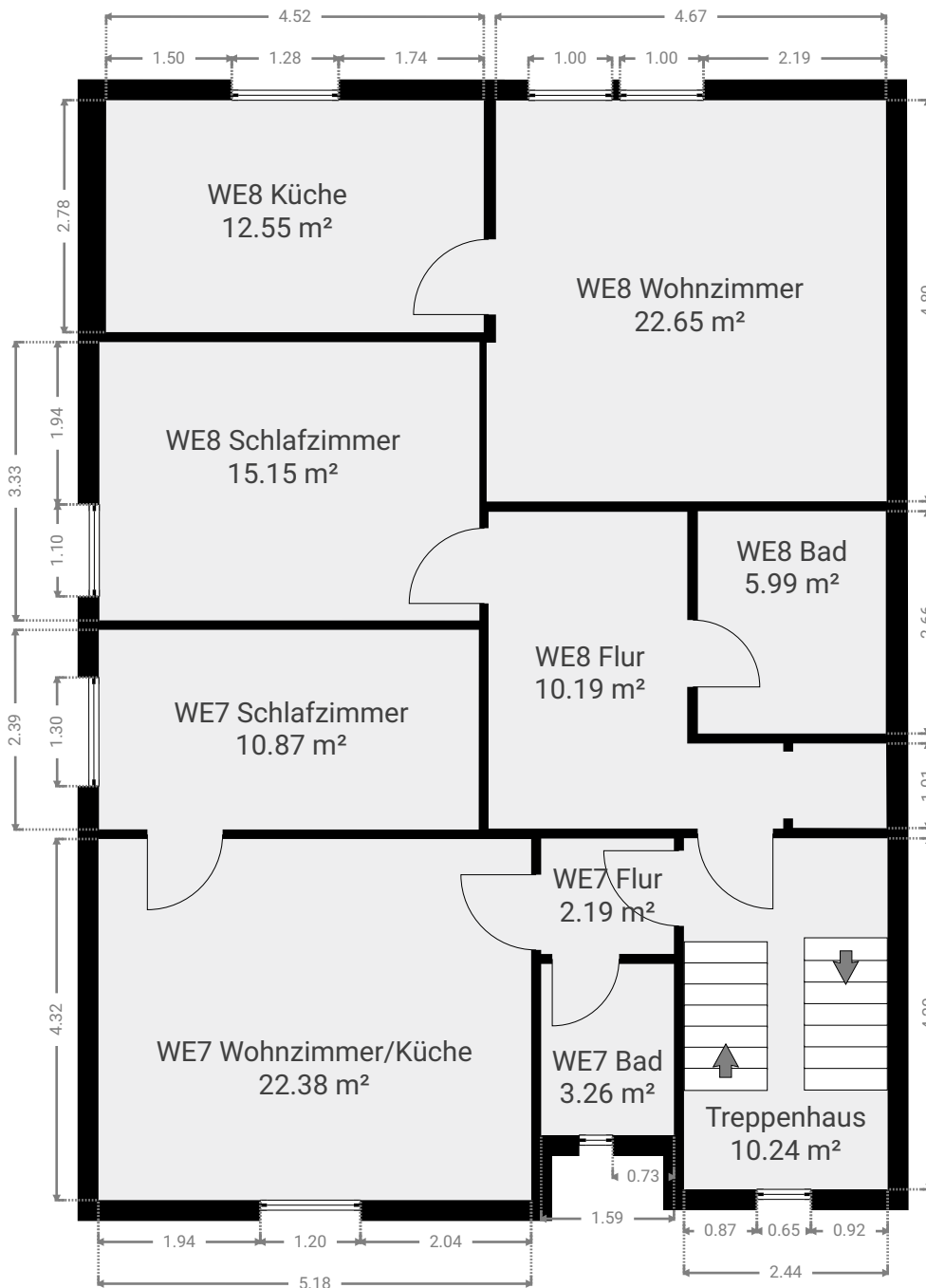

ETAGEN: 4

▼ **Treppenhaus**
Dachgeschoss

BREITE: 2.44 m • LÄNGE: 4.20 m
BEREICH: 10.24 m² • UMFANG: 13.28 m

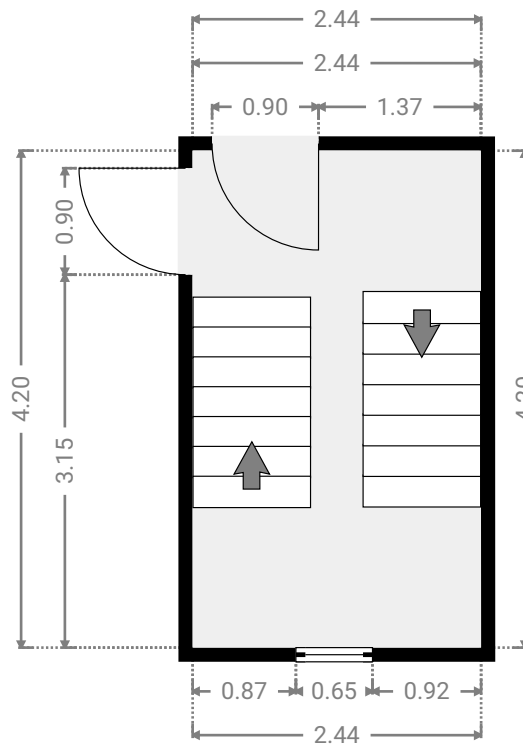
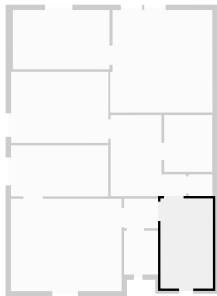

▼ **WE7 Bad**
Dachgeschoss

BREITE: 1.59 m • LÄNGE: 2.05 m
BEREICH: 3.26 m² • UMFANG: 7.28 m

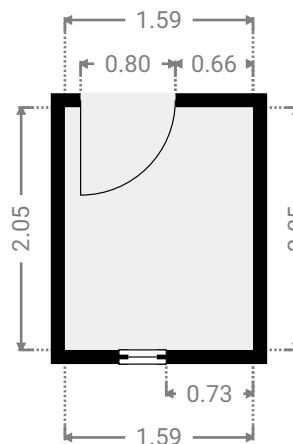
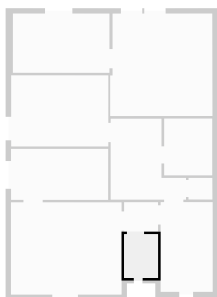

ETAGEN: 4

▼ **WE7 Flur**
Dachgeschoss

BREITE: 1.59 m · LÄNGE: 1.38 m
BEREICH: 2.19 m² · UMFANG: 5.94 m

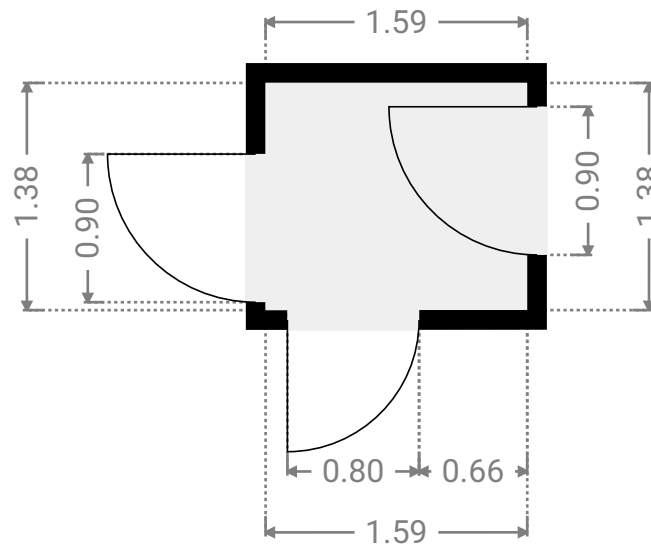
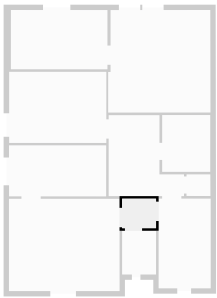

▼ **WE7 Schlafzimmer**
Dachgeschoss

BREITE: 4.55 m · LÄNGE: 2.39 m
BEREICH: 10.87 m² · UMFANG: 13.87 m

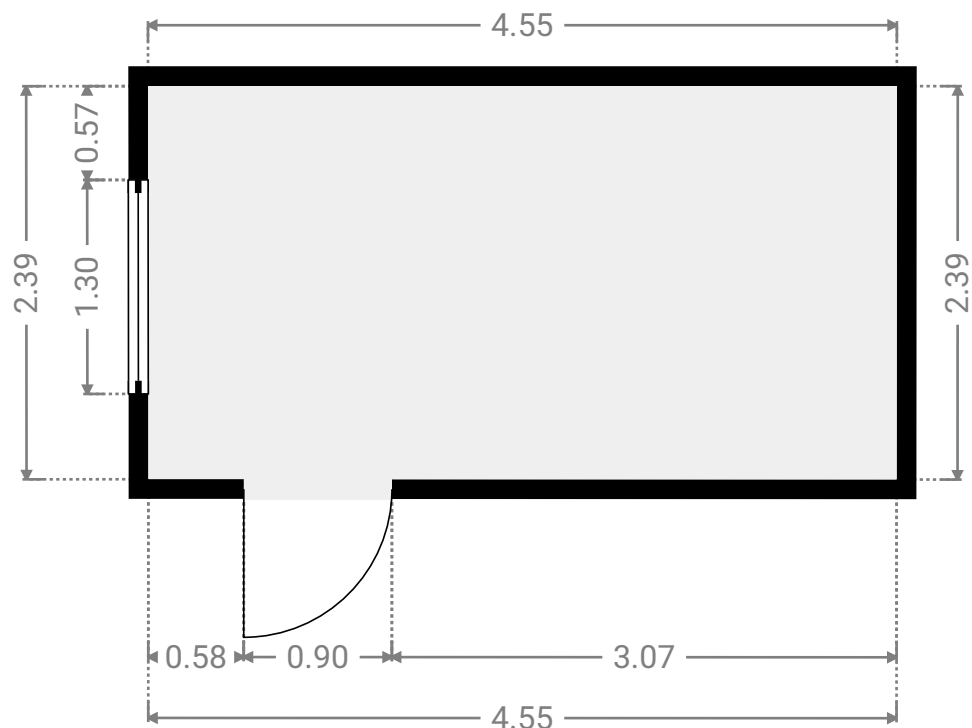
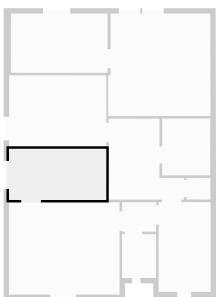

ETAGEN: 4

▼ **WE7 Wohnzimmer/Küche**
Dachgeschoss

BREITE: 5.18 m • LÄNGE: 4.32 m
BEREICH: 22.38 m² • UMFANG: 19.00 m

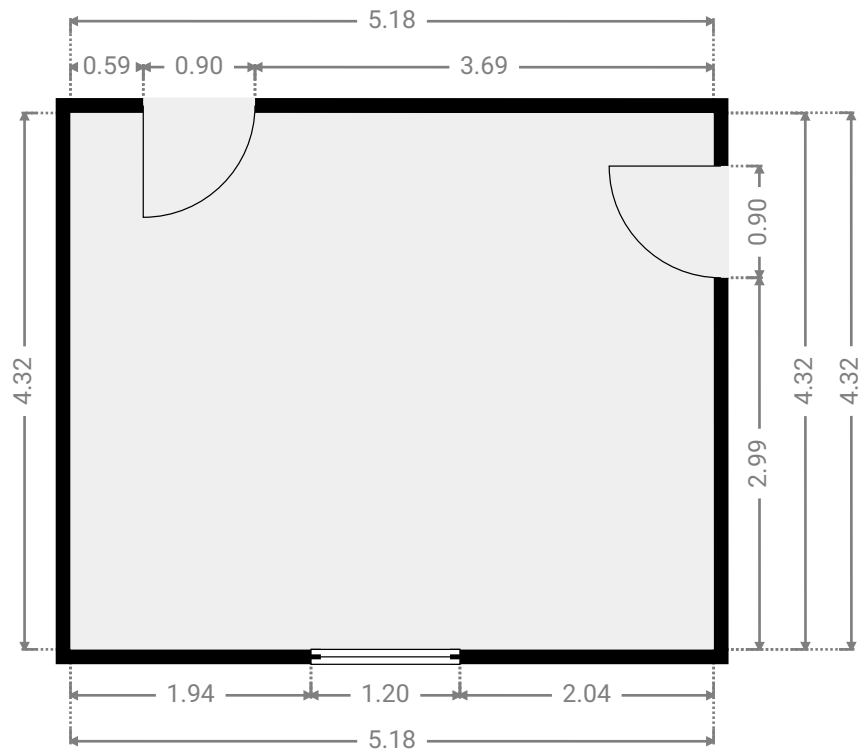
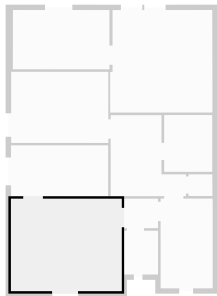

▼ **WE8 Abstellraum**
Dachgeschoss

BREITE: 1.12 m • LÄNGE: 1.01 m
BEREICH: 1.13 m² • UMFANG: 4.26 m

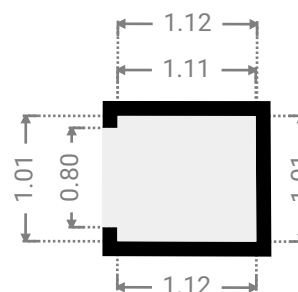
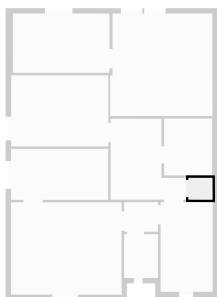

ETAGEN: 4

▼ **WE8 Bad**
Dachgeschoss

BREITE: 2.25 m • LÄNGE: 2.66 m
BEREICH: 5.99 m² • UMFANG: 9.82 m

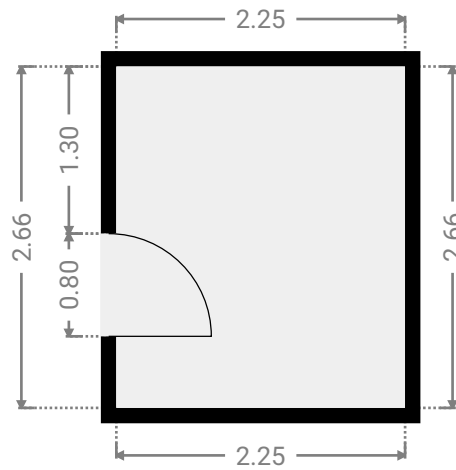
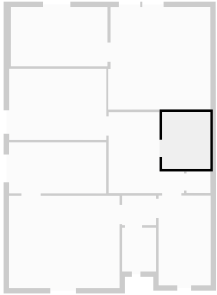

▼ **WE8 Flur**
Dachgeschoss

BREITE: 3.53 m • LÄNGE: 3.79 m
BEREICH: 10.19 m² • UMFANG: 14.64 m

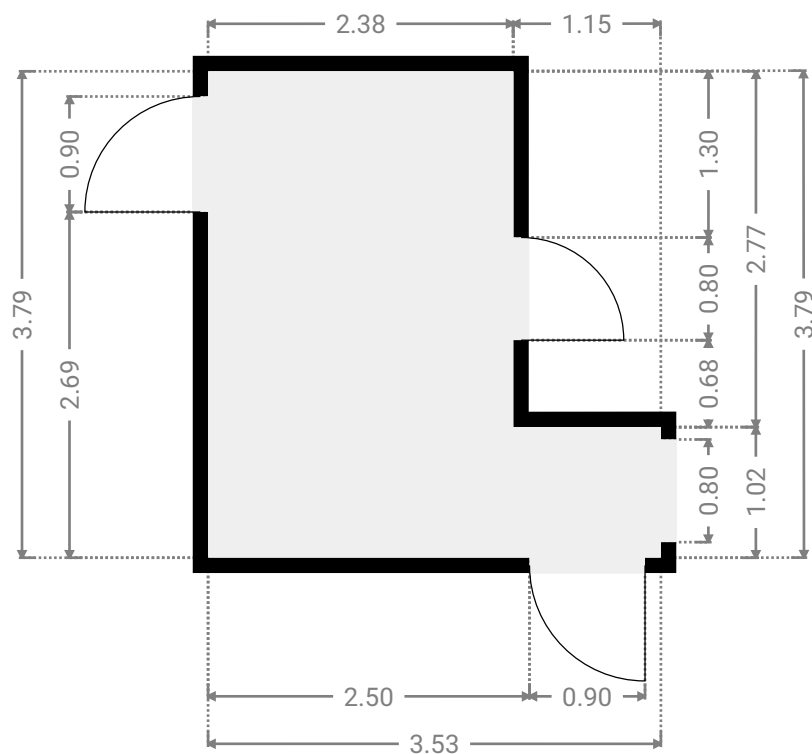
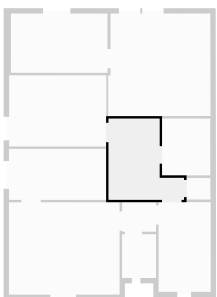

ETAGEN: 4

▼ **WE8 Küche**
Dachgeschoss

BREITE: 4.52 m • LÄNGE: 2.78 m
BEREICH: 12.55 m² • UMFANG: 14.60 m

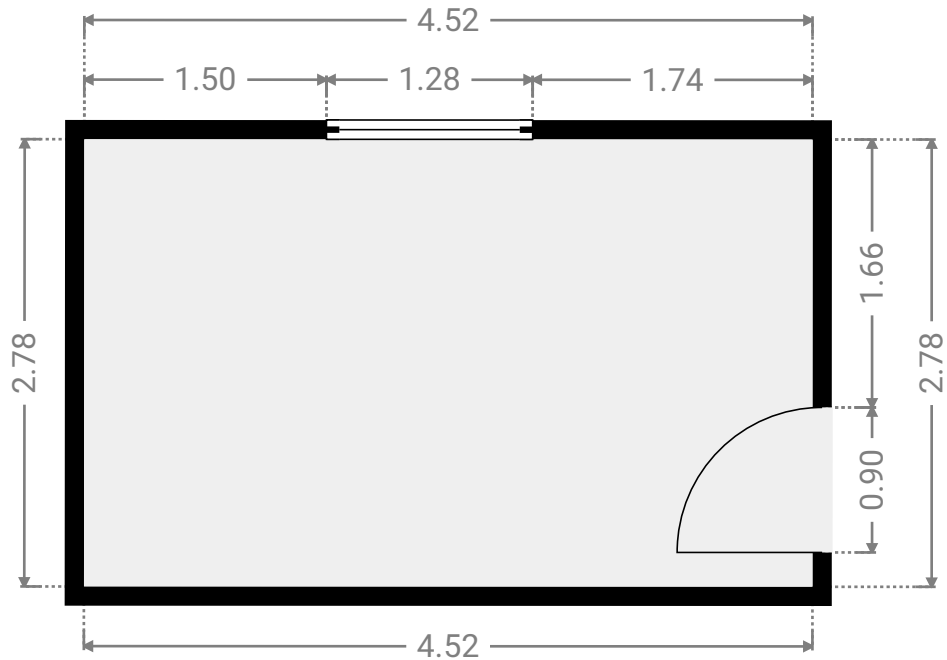
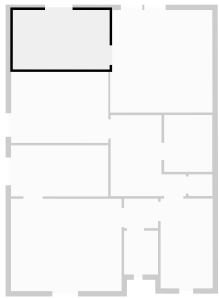

▼ **WE8 Schlafzimmer**
Dachgeschoss

BREITE: 4.55 m • LÄNGE: 3.33 m
BEREICH: 15.15 m² • UMFANG: 15.76 m

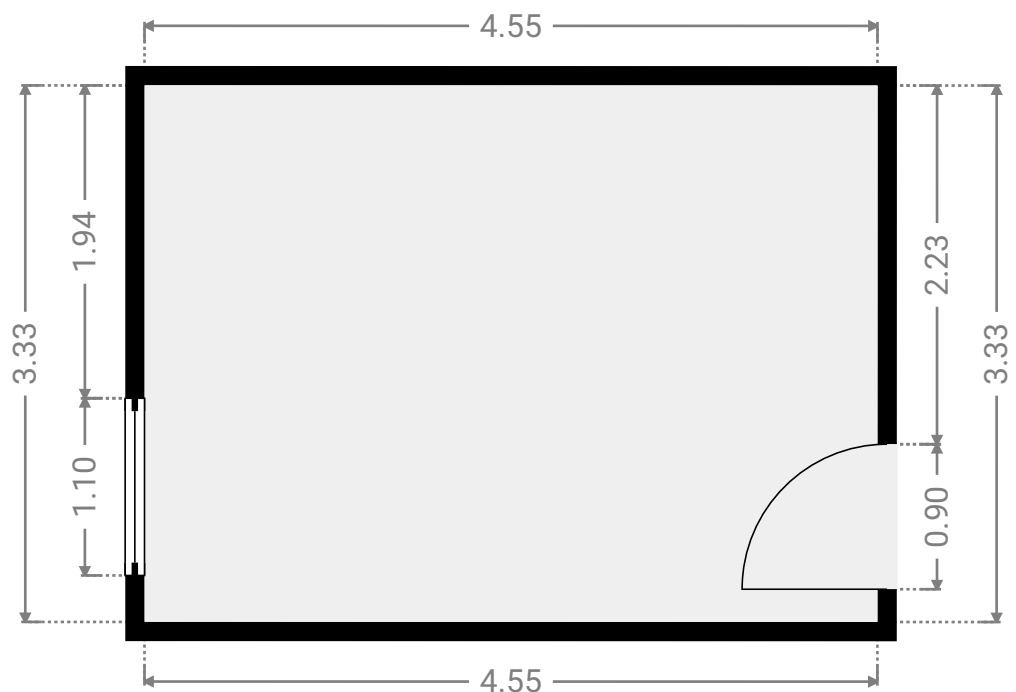
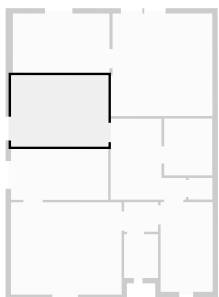

ETAGEN: 4

▼ **WE8 Wohnzimmer**
Dachgeschoss

BREITE: 4.79 m · LÄNGE: 4.80 m
BEREICH: 22.65 m² · UMFANG: 19.17 m

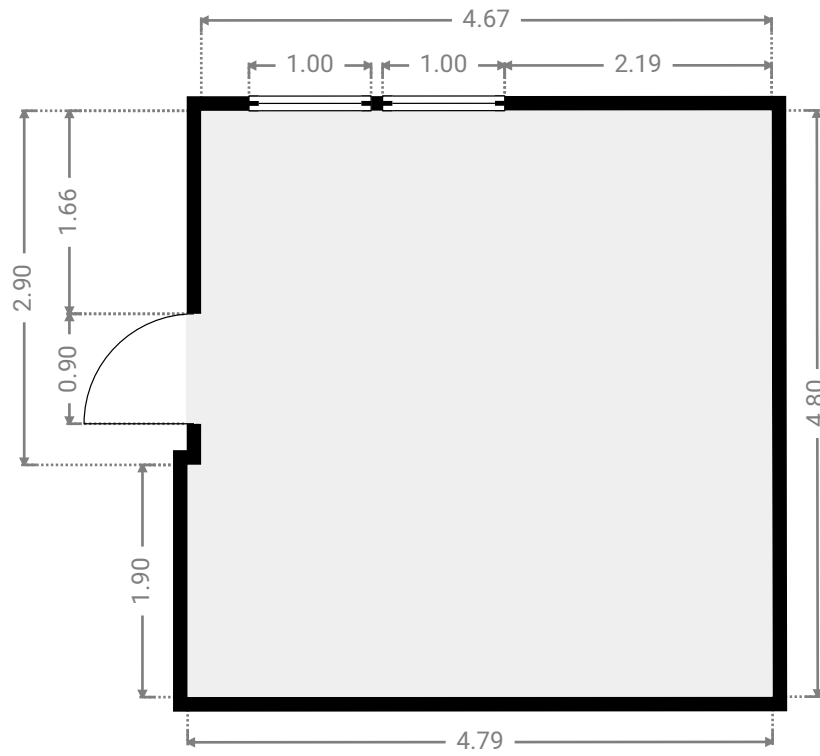
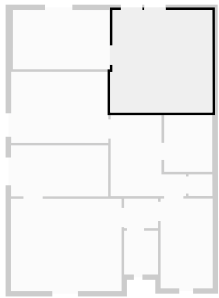

▼ Kellergeschoss

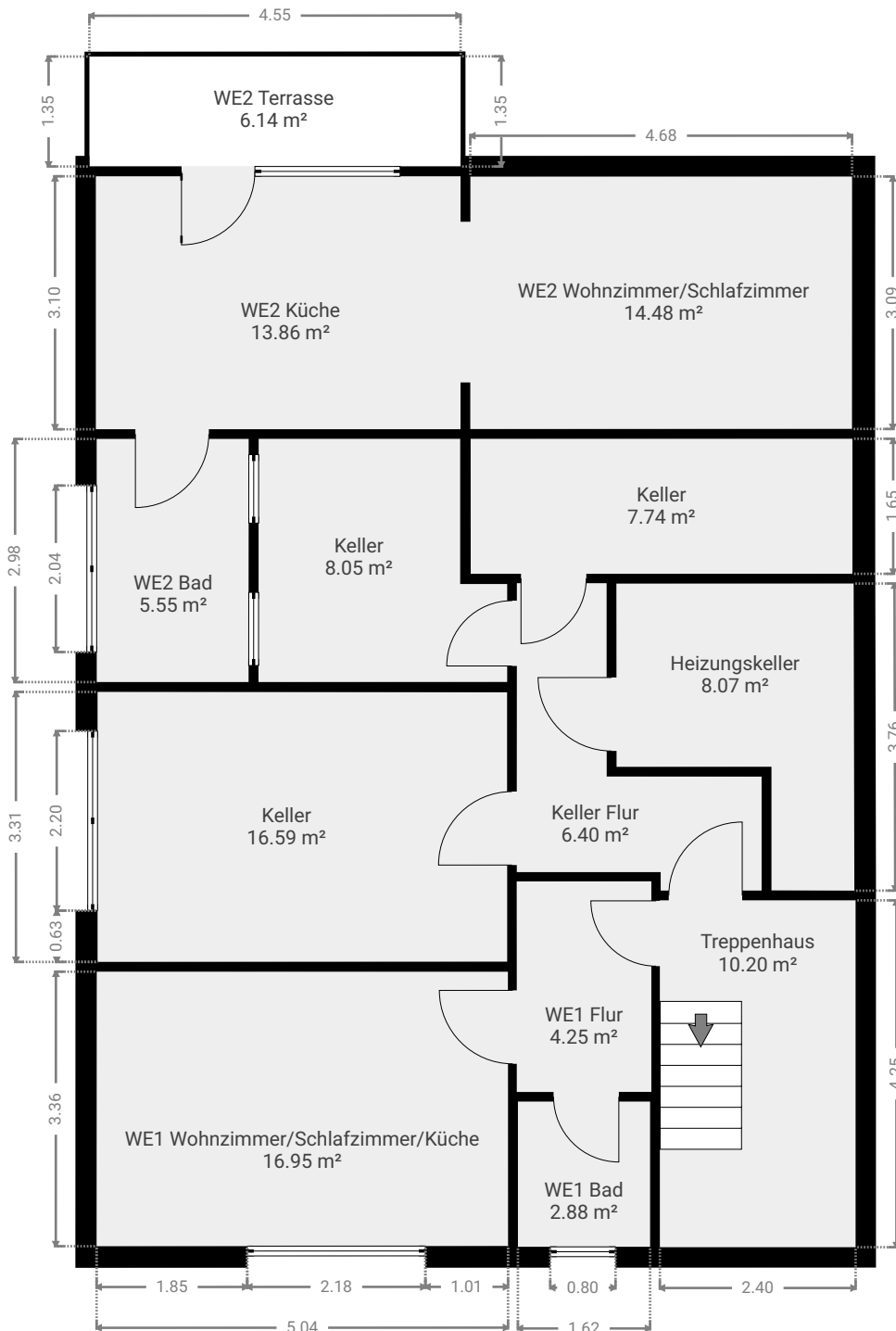

ETAGEN: 4

▼ **Heizungskeller**
Kellergeschoss

BREITE: 2.93 m • LÄNGE: 3.76 m
BEREICH: 8.07 m² • UMFANG: 13.35 m

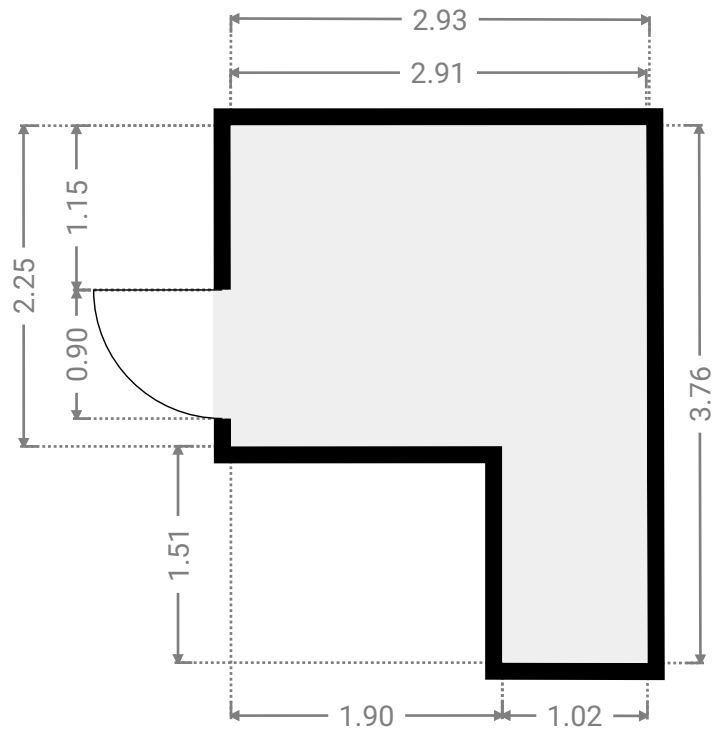
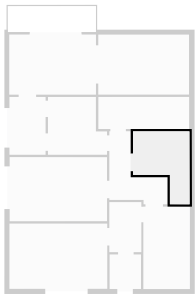

▼ **Keller**
Kellergeschoss

BREITE: 3.05 m • LÄNGE: 2.98 m
BEREICH: 8.05 m² • UMFANG: 12.05 m

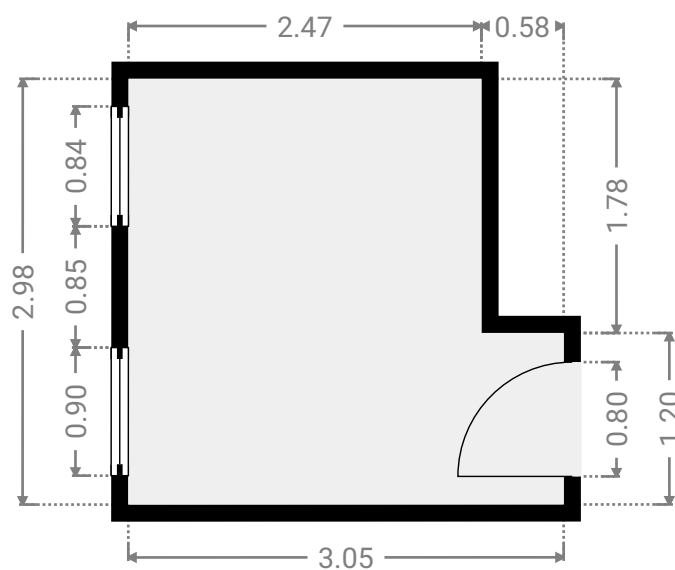
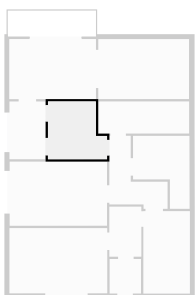

ETAGEN: 4

▼ **Keller**
Kellergeschoss

BREITE: 5.02 m · LÄNGE: 3.31 m
BEREICH: 16.59 m² · UMFANG: 16.65 m

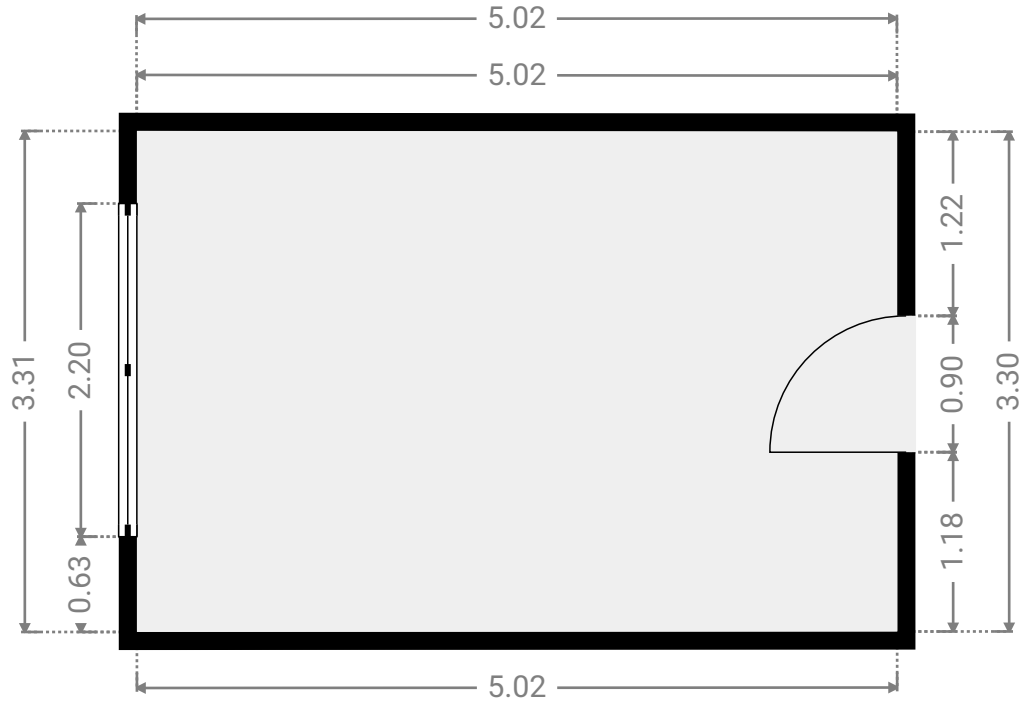
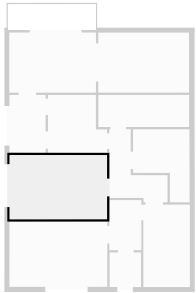

▼ **Keller**
Kellergeschoss

BREITE: 4.68 m · LÄNGE: 1.65 m
BEREICH: 7.74 m² · UMFANG: 12.67 m

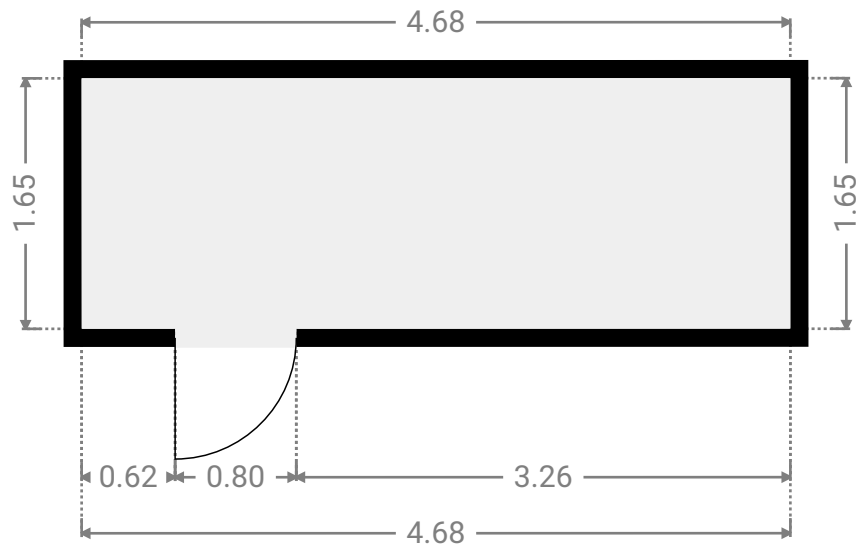
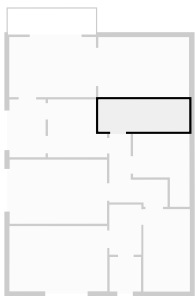

ETAGEN: 4

▼ **Keller Flur**
Kellergeschoss

BREITE: 3.00 m • LÄNGE: 3.77 m
BEREICH: 6.40 m² • UMFANG: 13.53 m

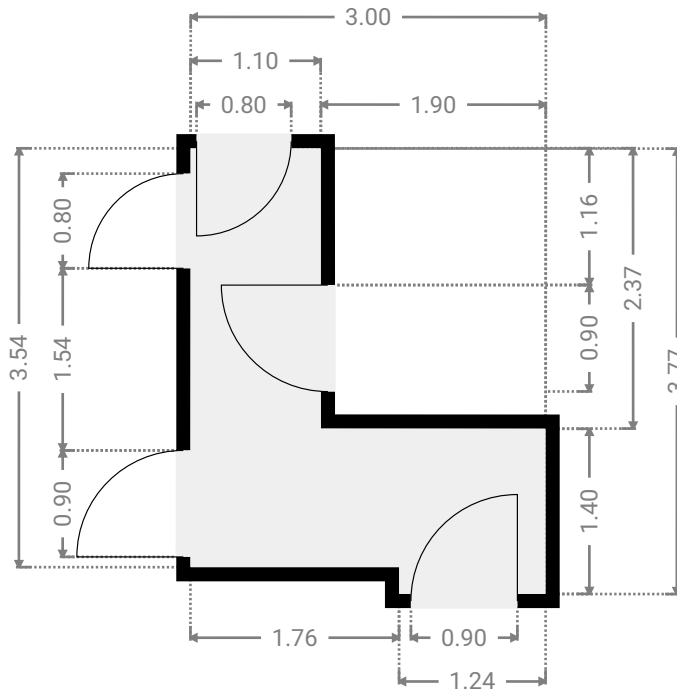
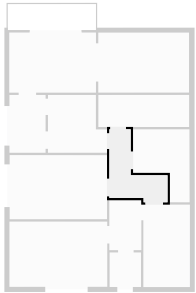

▼ **Treppenhaus**
Kellergeschoss

BREITE: 2.40 m • LÄNGE: 4.25 m
BEREICH: 10.20 m² • UMFANG: 13.30 m

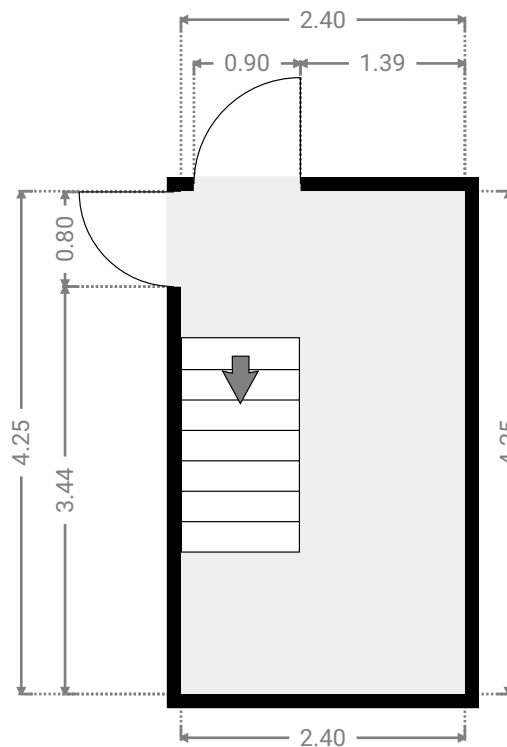
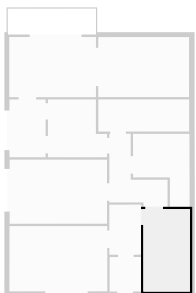

ETAGEN: 4

▼ **WE1 Bad**
Kellergeschoss

BREITE: 1.62 m • LÄNGE: 1.78 m
BEREICH: 2.88 m² • UMFANG: 6.80 m

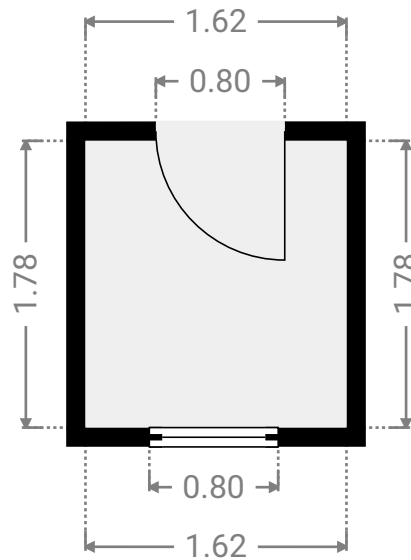

▼ **WE1 Flur**
Kellergeschoss

BREITE: 1.65 m • LÄNGE: 2.58 m
BEREICH: 4.25 m² • UMFANG: 8.46 m

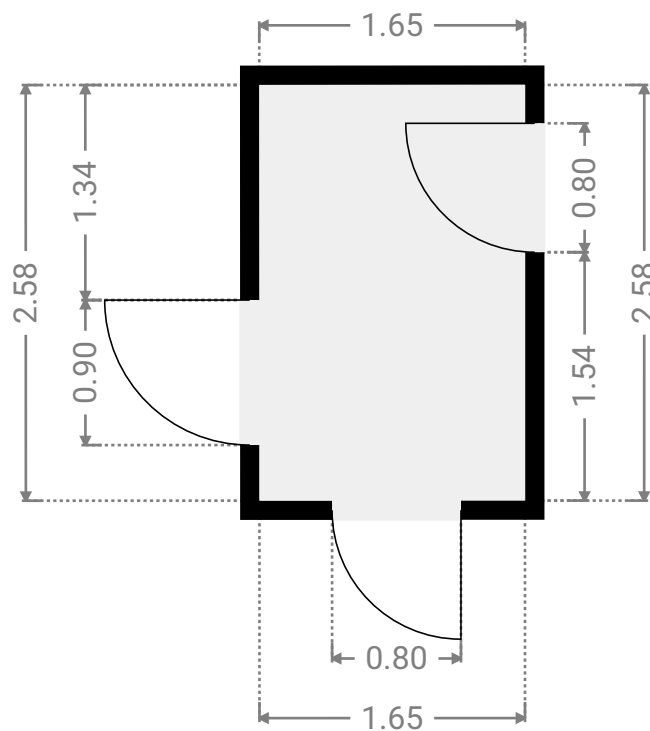

ETAGEN: 4

▼ **WE1 Wohnzimmer/Schlafzimmer/Küche**
Kellergeschoss

BREITE: 5.04 m • LÄNGE: 3.36 m
BEREICH: 16.95 m² • UMFANG: 16.81 m

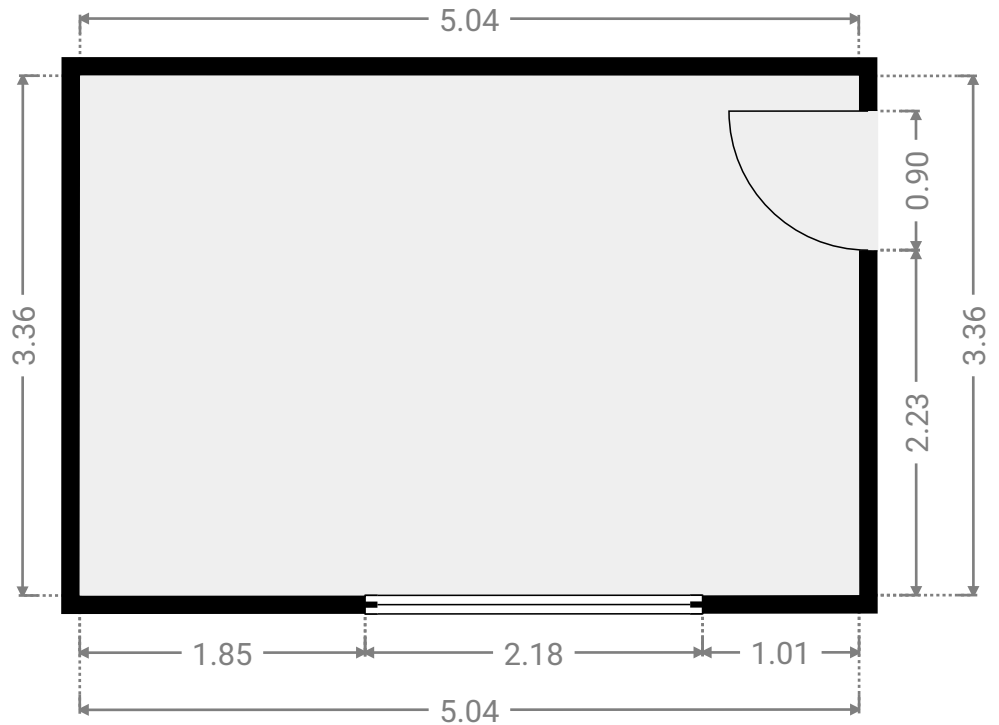
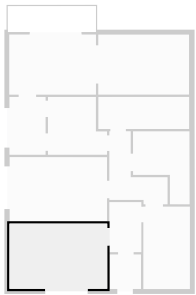

▼ **WE2 Bad**
Kellergeschoss

BREITE: 1.86 m • LÄNGE: 2.98 m
BEREICH: 5.55 m² • UMFANG: 9.68 m

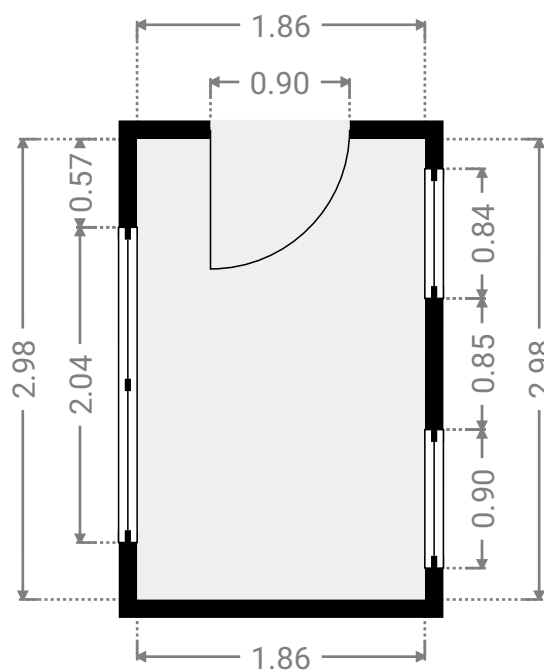
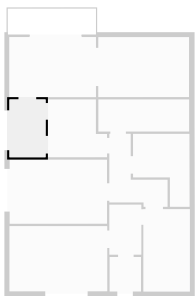

ETAGEN: 4

▼ **WE2 Küche**
Kellergeschoss

BREITE: 4.47 m · LÄNGE: 3.10 m
BEREICH: 13.86 m² · UMFANG: 15.14 m

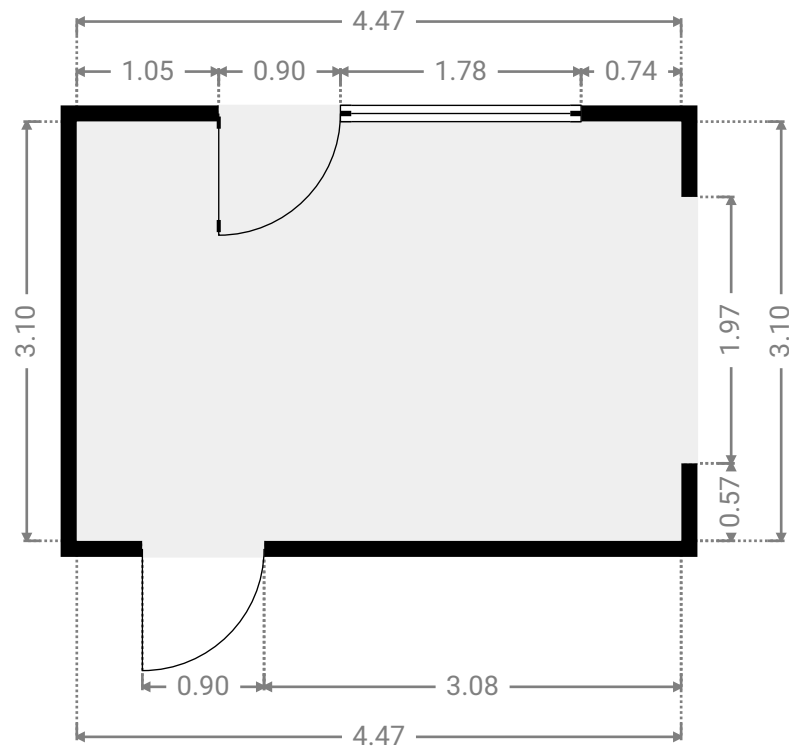
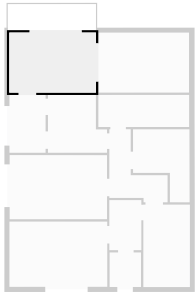

▼ **WE2 Terrasse**
Kellergeschoss

BREITE: 4.55 m · LÄNGE: 1.35 m
BEREICH: 6.14 m² · UMFANG: 11.80 m

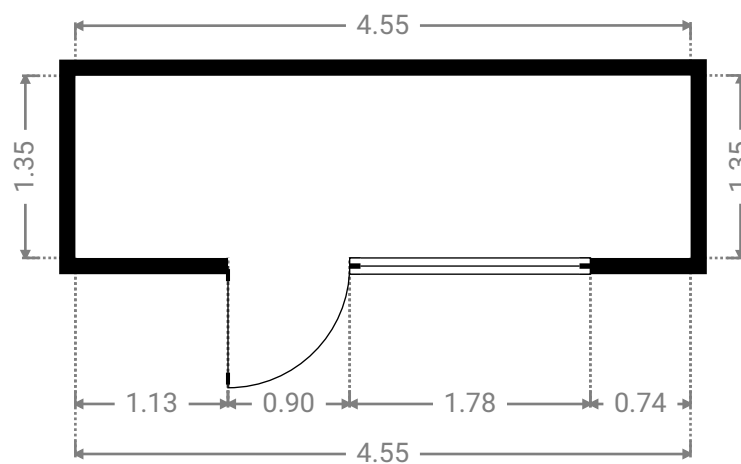
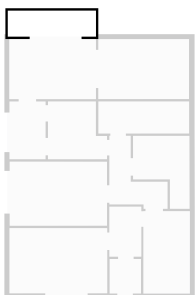

ETAGEN: 4

▼ **WE2 Wohnzimmer/Schlafzimmer**
Kellergeschoss

BREITE: 4.68 m · LÄNGE: 3.09 m
BEREICH: 14.48 m² · UMFANG: 15.55 m

